

AFG1000 Series  
Arbitrary Function Generator  
Specifications and Performance Verification  
Technical Reference

[www.tektronix.com](http://www.tektronix.com)



077-1132-02

**Tektronix**

Copyright © Tektronix. All rights reserved. Licensed software products are owned by Tektronix or its subsidiaries or suppliers, and are protected by national copyright laws and international treaty provisions.

Tektronix products are covered by U.S. and foreign patents, issued and pending. Information in this publication supersedes that in all previously published material. Specifications and price change privileges reserved.

TEKTRONIX and TEK are registered trademarks of Tektronix, Inc.

## Contacting Tektronix

Tektronix, Inc.  
14150 SW Karl Braun Drive  
P.O. Box 500  
Beaverton, OR 97077  
USA

For product information, sales, service, and technical support:

- In North America, call 1-800-833-9200.
- Worldwide, visit [www.tektronix.com](http://www.tektronix.com) to find contacts in your area.

## Warranty

Tektronix warrants that the product will be free from defects in materials and workmanship for a period of three (3) years from the date of original purchase from an authorized Tektronix distributor. If the product proves defective during this warranty period, Tektronix, at its option, either will repair the defective product without charge for parts and labor, or will provide a replacement in exchange for the defective product. Parts, modules and replacement products used by Tektronix for warranty work may be new or reconditioned to like new performance. All replaced parts, modules and products become the property of Tektronix.

In order to obtain service under this warranty, Customer must notify Tektronix of the defect before the expiration of the warranty period and make suitable arrangements for the performance of service. Customer shall be responsible for packaging and shipping the defective product to the service center designated by Tektronix, shipping charges prepaid, and with a copy of customer proof of purchase. Tektronix shall pay for the return of the product to Customer if the shipment is to a location within the country in which the Tektronix service center is located. Customer shall be responsible for paying all shipping charges, duties, taxes, and any other charges for products returned to any other locations.

This warranty shall not apply to any defect, failure or damage caused by improper use or improper or inadequate maintenance and care. Tektronix shall not be obligated to furnish service under this warranty a) to repair damage resulting from attempts by personnel other than Tektronix representatives to install, repair or service the product; b) to repair damage resulting from improper use or connection to incompatible equipment; c) to repair any damage or malfunction caused by the use of non-Tektronix supplies; or d) to service a product that has been modified or integrated with other products when the effect of such modification or integration increases the time or difficulty of servicing the product.

**THIS WARRANTY IS GIVEN BY TEKTRONIX WITH RESPECT TO THE PRODUCT IN LIEU OF ANY OTHER WARRANTIES, EXPRESS OR IMPLIED. TEKTRONIX AND ITS VENDORS DISCLAIM ANY IMPLIED WARRANTIES OF MERCHANTABILITY OR FITNESS FOR A PARTICULAR PURPOSE. TEKTRONIX' RESPONSIBILITY TO REPAIR OR REPLACE DEFECTIVE PRODUCTS IS THE SOLE AND EXCLUSIVE REMEDY PROVIDED TO THE CUSTOMER FOR BREACH OF THIS WARRANTY. TEKTRONIX AND ITS VENDORS WILL NOT BE LIABLE FOR ANY INDIRECT, SPECIAL, INCIDENTAL, OR CONSEQUENTIAL DAMAGES IRRESPECTIVE OF WHETHER TEKTRONIX OR THE VENDOR HAS ADVANCE NOTICE OF THE POSSIBILITY OF SUCH DAMAGES.**

[W2 – 15AUG04]



---

## Table of contents

Important safety information .....	iii
Preface .....	1
Finding other information.....	2
Manual conventions .....	2
Specifications.....	3
Electrical specifications .....	3
Input and output specifications.....	9
General specifications.....	10
Performance tests.....	12
Test record .....	14
Frequency/Period test .....	20
Amplitude test .....	21
DC offset test .....	23
Counter test .....	24
AC flatness test .....	26
Harmonics distortion test.....	28
Total harmonic distortion test.....	30

## List of figures

Figure 1: AFG1000 Series dimensions .....	11
Figure 2: Frequency/Period tests.....	20
Figure 3: 50 $\Omega$ terminator accuracy .....	21
Figure 4: Amplitude tests .....	22
Figure 5: 50 $\Omega$ terminator accuracy .....	23
Figure 6: DC offset tests.....	23
Figure 7: Counter tests .....	24
Figure 8: AC flatness tests for 1 kHz .....	26
Figure 9: AC flatness tests for the frequency greater than 100 kHz .....	26
Figure 10: Harmonic distortion tests.....	28
Figure 11: Total harmonic distortion tests .....	30

## List of tables

Table 1: Supported products .....	1
Table 2: Operating mode.....	3
Table 3: Waveforms .....	3
Table 4: Frequency/Period .....	4
Table 5: Channel Coupling, Channel Copy.....	4
Table 6: Amplitude.....	5
Table 7: DC offset.....	5
Table 8: Counter Specification.....	5
Table 9: Output characteristics.....	6
Table 10: Modulation .....	7
Table 11: Front panel .....	9
Table 12: Rear panel .....	9
Table 13: Power .....	10
Table 14: Export control .....	10
Table 15: Environmental.....	10
Table 16: System characteristics .....	10
Table 17: Performance test items .....	12
Table 18: Test equipment.....	13
Table 19: Series Performance Test Record .....	15

---

## Important safety information

This manual contains information and warnings that must be followed by the user for safe operation and to keep the product in a safe condition. To safely perform service on this product, additional information is provided at the end of this section. (See page v, *Service safety summary*.)

### General safety summary

Use the product only as specified. Review the following safety precautions to avoid injury and prevent damage to this product or any products connected to it. Carefully read all instructions. Retain these instructions for future reference.

Comply with local and national safety codes.

For correct and safe operation of the product, it is essential that you follow generally accepted safety procedures in addition to the safety precautions specified in this manual.

The product is designed to be used by trained personnel only. Only qualified personnel who are aware of the hazards involved should remove the cover for repair, maintenance, or adjustment.

Before use, always check the product with a known source to be sure it is operating correctly.

This product is not intended for detection of hazardous voltages. Use personal protective equipment to prevent shock and arc blast injury where hazardous live conductors are exposed.

While using this product, you may need to access other parts of a larger system. Read the safety sections of the other component manuals for warnings and cautions related to operating the system. When incorporating this equipment into a system, the safety of that system is the responsibility of the assembler of the system.

### To avoid fire or personal injury

**Use proper power cord.** Use only the power cord specified for this product and certified for the country of use.

**Use proper voltage setting.** Before applying power, make sure that the line selector is in the proper position for the source being used.

**Ground the product.** This product is grounded through the grounding conductor of the power cord. To avoid electric shock, the grounding conductor must be connected to earth ground. Before making connections to the input or output terminals of the product, make sure that the product is properly grounded.

**Power disconnect.** The power cord disconnects the product from the power source. See instructions for the location. Do not position the equipment so that it is difficult to operate the power cord; it must remain accessible to the user at all times to allow for quick disconnection if needed.

**Observe all terminal ratings.** To avoid fire or shock hazard, observe all ratings and markings on the product. Consult the product manual for further ratings information before making connections to the product.

**Do not operate without covers.** Do not operate this product with covers or panels removed, or with the case open. Hazardous voltage exposure is possible.

**Avoid exposed circuitry.** Do not touch exposed connections and components when power is present.

**Do not operate with suspected failures.** If you suspect that there is damage to this product, have it inspected by qualified service personnel. Disable the product if it is damaged. Do not use the product if it is damaged or operates incorrectly. If in doubt about safety of the product, turn it off and disconnect the power cord. Clearly mark the product to prevent its further operation.

Before use, inspect voltage probes, test leads, and accessories for mechanical damage and replace when damaged. Do not use probes or test leads if they are damaged, if there is exposed metal, or if a wear indicator shows.

Examine the exterior of the product before you use it. Look for cracks or missing pieces.

Use only specified replacement parts.

**Use proper fuse.** Use only the fuse type and rating specified for this product.

**Do not operate in wet/damp conditions.** Be aware that condensation may occur if a unit is moved from a cold to a warm environment.

**Do not operate in an explosive atmosphere.**

**Keep product surfaces clean and dry.** Remove the input signals before you clean the product.

**Provide proper ventilation.** Refer to the installation instructions in the manual for details on installing the product so it has proper ventilation.

Slots and openings are provided for ventilation and should never be covered or otherwise obstructed. Do not push objects into any of the openings.



**Provide a safe working environment.** Always place the product in a location convenient for viewing the display and indicators.  
Avoid improper or prolonged use of keyboards, pointers, and button pads. Improper or prolonged keyboard or pointer use may result in serious injury. Be sure your work area meets applicable ergonomic standards. Consult with an ergonomics professional to avoid stress injuries. Use care when lifting and carrying the product.

Use only the Tektronix rackmount hardware specified for this product.

## Service safety summary

The *Service safety summary* section contains additional information required to safely perform service on the product. Only qualified personnel should perform service procedures. Read this *Service safety summary* and the *General safety summary* before performing any service procedures.

**To avoid electric shock.** Do not touch exposed connections.

**Do not service alone.** Do not perform internal service or adjustments of this product unless another person capable of rendering first aid and resuscitation is present.

**Disconnect power.** To avoid electric shock, switch off the product power and disconnect the power cord from the mains power before removing any covers or panels, or opening the case for servicing.

**Use care when servicing with power on.** Dangerous voltages or currents may exist in this product. Disconnect power, remove battery (if applicable), and disconnect test leads before removing protective panels, soldering, or replacing components.

**Verify safety after repair.** Always recheck ground continuity and mains dielectric strength after performing a repair.

## Terms in this manual

These terms may appear in this manual:



**WARNING.** *Warning statements identify conditions or practices that could result in injury or loss of life.*



**CAUTION.** *Caution statements identify conditions or practices that could result in damage to this product or other property.*

## Symbols and terms on the product

These terms may appear on the product:

- **DANGER** indicates an injury hazard immediately accessible as you read the marking.
- **WARNING** indicates an injury hazard not immediately accessible as you read the marking.
- **CAUTION** indicates a hazard to property including the product.



When this symbol is marked on the product, be sure to consult the manual to find out the nature of the potential hazards and any actions which have to be taken to avoid them. (This symbol may also be used to refer the user to ratings in the manual.)

The following symbol(s) may appear on the product:

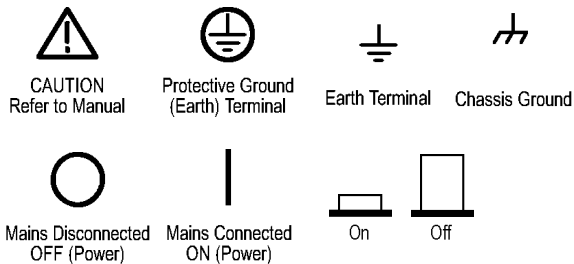

---

# Preface

This manual provides instructions to verify the performance of the AFG1000 Series Arbitrary Function Generator to the module level.

Unless noted otherwise, the term “AFG3000 Series” refers to the models in the following table.

**Table 1: Supported products**

AFG1022
AFG1062

To prevent personal injury or damage to the arbitrary function generator, consider the following before attempting service:

- The procedures in this manual should be performed only by a qualified service person.
- Read the *General Safety Summary* and the *Service Safety Summary* at the beginning of this document.

When using this manual for servicing, be sure to follow all warnings, cautions and notes.

The manual consists of the following sections:

- *Specifications* contains a description of the arbitrary function generator and the characteristics that apply to it.
- *Performance tests* contains procedures for confirming that the arbitrary function generator functions properly and meets warranted limits.

The procedures described in this document should be performed every 12 months or after module replacement.

If the instruments do not meet performance criteria, repair is necessary.

## Finding other information

This manual focuses on the performance verification of the arbitrary function generator. See the following list for other documents supporting the instrument. All documents except the Online Help are on the AFG1000 Series Arbitrary Function Generator Documentation CD-ROM that ship with instrument.

Document	Description
<i>AFG1000 Series Quick Start User Manual</i>	A quick reference to major features of the instrument and how they operate. It also provides several tutorials to familiarize you with basic instrument features.
<i>AFG1000 Series Programmer Manual</i>	An encyclopedia of topics that describe the arbitrary function generator interface and features, and gives background information on how to use them. It provides Menu Structures, User Interface and Programming Information.
<i>AFG1000 Series Compliance and Safety Instructions</i>	This document contains compliance and safety information.
<i>AFG1000 Series Online Help</i>	A online help system, integrated with the User Interface application that ships with this product. The help is preinstalled in the instrument.

## Manual conventions

This manual uses certain conventions that you should become familiar with.

- Modules** Throughout this manual, any replaceable component, assembly, or part of the arbitrary function generator is referred to generically as a module. In general, a module is an assembly (such as a circuit board). Sometimes a single component is a module; for example, the chassis of the arbitrary function generator is a module.
- Safety** Symbols and terms related to safety appear in the Safety Summary near the beginning of this manual.

# Specifications

These specifications apply to the AFG1000 Series Arbitrary Function Generator. All specifications are guaranteed unless labeled "typical". Typical specifications are provided for your convenience but are not guaranteed.

Specifications that are check marked with the ✓ symbol are checked directly (or indirectly) in the Performance tests section.

All specifications apply to the arbitrary function generator unless noted otherwise. These specifications are valid under the following conditions:

- The instrument must have been calibrated/adjusted at an ambient temperature between +20 °C and +30 °C.
- The instrument must be operating at an ambient temperature between 0 °C and +40 °C.
- The instrument must have had a warm-up period of at least 30 minutes.
- The instrument must be in an environment with temperature, altitude and humidity within the operating limits described in these specifications.

## Electrical specifications

Table 2: Operating mode

Characteristic	Description
Run mode	Continuous, Modulation, Sweep, and Burst

Table 3: Waveforms

Characteristic	Description
Standard	Sine, Square, Ramp, Pulse, Noise
Numbers of channel	2
Arbitrary waveform	Exponential rise, Exponential fall, Sin(x)/x, Staircase, DC, etc. 45 built-in waveforms, User Defined
Waveform length	
AFG1022	2 to 8,192
AFG1062	2 to 1M
Sampling rate	
AFG1022	125 MS/s
AFG1062	300 MS/s
Resolution	14 bits
Number of non-volatile waveform memories	256
Memory size	64 Mbyte for waveform storage

## Specifications

**Table 4: Frequency/Period**

Characteristic	Description	PV ref page
Frequency range		
Sine		
AFG1022		
Range	1 $\mu$ Hz to 25 MHz	
Sine wave in burst mode	2 mHz to 25 MHz	
AFG1062		
Range	1 $\mu$ Hz to 60 MHz	
Sine wave in burst mode	2 mHz to 30 MHz	
Square		
AFG1022		
Range	1 $\mu$ Hz to 12.5 MHz	
Square wave in burst mode	2 mHz to 12.5 MHz	
AFG1062		
Range	1 $\mu$ Hz to 30 MHz	
Square wave in burst mode	2 mHz to 15 MHz	
Pulse		
AFG1022		
Range	1 $\mu$ Hz to 12.5 MHz	
Pulse wave in burst mode	2 mHz to 12.5 MHz	
AFG1062		
Range	1 $\mu$ Hz to 30 MHz	
Pulse wave in burst mode	2 mHz to 15 MHz	
Ramp		
AFG1022		
Range	1 $\mu$ Hz to 1 MHz	
Ramp wave in burst mode	2 mHz to 1 MHz	
AFG1062		
Range	1 $\mu$ Hz to 2 MHz	
Ramp wave in burst mode	2 mHz to 2 MHz	
Arbitrary		
AFG1022		
Range	1 $\mu$ Hz to 10 MHz	
Sine wave in burst mode	2 mHz to 10 MHz	
AFG1062		
Range	1 $\mu$ Hz to 30 MHz	
Arb wave in burst mode	2 mHz to 30 MHz	
Noise bandwidth (-3 dB), typical		
AFG1022	25 MHz	
AFG1062	50 MHz	
Resolution	1 $\mu$ Hz or 12 digits	
✓ Accuracy (stability)	$\pm 1$ ppm, 0 °C to 40 °C	(See page 20, Frequency/Period test.)
✓ Accuracy (aging)	$\pm 1$ ppm/year	

**Table 5: Channel Coupling, Channel Copy**

Characteristics	Description
Phase Deviation <sup>1</sup>	0.0° to +360.0° (Frequency CH1 = CH2) Support frequency/amplitude/phase copying

<sup>1</sup> Resolution: 0.1°

Table 6: Amplitude

Characteristic	Description	PV ref page
Range		
AFG1022	1 mV <sub>p-p</sub> to 10 V <sub>p-p</sub> (into 50 Ω load) 2 mV <sub>p-p</sub> to 20 V <sub>p-p</sub> (into Open circuit or High-Z)	
AFG1062	≤ 25 MHz: 1 mV <sub>p-p</sub> to 10 V <sub>p-p</sub> > 25 MHz: 1 mV <sub>p-p</sub> to 5 V <sub>p-p</sub> (into 50 Ω load) ≤ 25 MHz: 2 mV <sub>p-p</sub> to 20 V <sub>p-p</sub> > 25 MHz: 2 mV <sub>p-p</sub> to 10 V <sub>p-p</sub> (into Open circuit or High-Z)	
✓ Accuracy	±(1% of setting +1 mV <sub>p-p</sub> ) (at 1 kHz sine waveform), 0 V offset	(See page 21, <i>Amplitude test.</i> )
Resolution	1 mV <sub>p-p</sub> or 4 digits	
Units <sup>1</sup>	V <sub>p-p</sub> , V <sub>rms</sub> , and Volt (High level and Low level)	
Output impedance	50 Ω	

<sup>1</sup> V<sub>rms</sub> is not available for Pulse, Noise, and Arb waveforms.

Table 7: DC offset

Characteristic	Description	PV ref page
Range	±(5 V <sub>pk</sub> – Amplitude V <sub>p-p</sub> /2) into 50 Ω load ±(10 V <sub>pk</sub> – Amplitude V <sub>p-p</sub> /2) into Open circuit or High-Z	
✓ Accuracy	±(1 % of  setting  + 1 mV + amplitude V <sub>p-p</sub> * 0.5%)	(See page 23, <i>DC offset test.</i> )
Resolution	1 mV	
Output impedance	50 Ω (typical)	

Table 8: Counter Specification

Characteristic	Description	PV ref page
Function	Frequency, period, positive Pulse width, Duty cycle	
Frequency Range	100 mHz to 200 MHz	
✓ Frequency Resolution	6 digits	(See page 24, <i>Counter test.</i> )
Coupling mode	AC, DC	
Voltage Range and Sensitivity, DC coupled (non-modulation signal)		
100 mHz to 100 MHz	250 mV <sub>p-p</sub> to 5 V <sub>p-p</sub> (AC+DC)	
100 MHz to 200 MHz	450 mV <sub>p-p</sub> to 3 V <sub>p-p</sub> (AC+DC)	
Voltage Range and Sensitivity, AC coupled (non-modulation signal)		
1 Hz to 100 MHz	250 mV <sub>p-p</sub> to 5 V <sub>p-p</sub>	
100 MHz to 200 MHz	450 mV <sub>p-p</sub> to 4 V <sub>p-p</sub>	
Pulse width and Duty cycle Measure	1 Hz to 10 MHz	
Input impedance	1 MΩ with 100 pF parallel	
High frequency noise restraint (HFR)	On / Off (HFR frequency = 500 kHz)	
Sensitivity	Low, Middle, High	
Trigger level range	± 2.5 V	

Table 9: Output characteristics

Characteristic	Description	PV ref page
Sine wave		
✓ Flatness (at 1.0 V <sub>p-p</sub> amplitude, relative to 1 kHz)		(See page 26, AC flatness test.)
AFG1022	< 10 MHz: ±0.4 dB 10 MHz ≤ frq ≤ 25 MHz: ±0.7 dB	
AFG1062	< 10 MHz: ±0.5 dB 10 MHz ≤ frq ≤ 60 MHz: ±0.9 dB	
✓ Harmonic distortion (at 1.0 V <sub>p-p</sub> amplitude)		(See page 28, Harmonics distortion test.)
AFG1022	1 μHz to 25 MHz: < -50 dBc	
AFG1062	Typical (0 dBm) DC to 10 MHz (included): <-60 dBc 10 MHz to 60 MHz (included): <-47 dBc	
✓ Total harmonic distortion (THD)	(at 1 V <sub>p-p</sub> amplitude) 10 Hz to 20 kHz: < 0.2%	(See page 30, Total harmonic distortion test.)
Phase noise, typical	(at 1 V <sub>p-p</sub> amplitude) 1 MHz: < -110 dBc/Hz at 10 kHz offset	
Spurious (nonharmonic)	(at 1 V <sub>p-p</sub> amplitude) Typical (0 dBm): <-45 dBc	
Residual clock noise, typical	-57 dBm	
Square wave		
Rise time/fall time (at 1 V <sub>p-p</sub> amplitude), typical		
AFG1022	< 12 ns	
AFG1062	< 10 ns	
Jitter (rms), typical		
AFG1022	< 1 ns	
AFG1062	< 500 ps	
Overshoot	< 5%	
Duty Cycle	50% fixed	
Pulse		
Pulse width		
AFG1022	40 ns to 999 ks	
AFG1062	17 ns to 999 ks	
Resolution	1 ns or 4 digits	
Duty Cycle		
AFG1022	< 1 MHz: Adjustable Duty 1 MHz ≤ frq ≤ 12.5 MHz: 50% (limitations of pulse duty width apply)	
AFG1062	< 1 MHz: Adjustable Duty 1 MHz ≤ frq ≤ 30 MHz: 50% (limitations of pulse duty width apply)	



Table 9: Output characteristics (cont.)

Characteristic	Description	PV ref page
Rising/Falling Edge Time, typical		
AFG1022	< 12 ns (Fixed)	
AFG1062	< 10 ns (Fixed)	
Overshoot, typical	< 5%	
Jitter (rms), typical		
AFG1022	< 1 ns	
AFG1062	< 500 ps	
Ramp		
Linearity, typical	(at frequency: 1 kHz, amplitude: 1 V <sub>p-p</sub> , symmetry: 50%) < 0.1% of peak output	
Symmetry	0% to 100%	
Noise		
Type	White Gaussian	
Arbitrary		
Rise time/fall time, typical		
AFG1022	< 10 ns	
AFG1062	< 8 ns	
Jitter (rms), typical	< 6 ns	

Table 10: Modulation

Characteristic	Description
AM (Amplitude Modulation)	
Carrier waveforms	Sine, Square, Ramp, and Arbitrary
Modulation source	Internal or External
Internal modulating waveforms	Sine, Square, Ramp, Noise, and Arbitrary
Internal modulating frequency	2 mHz to 20.0 kHz
Depth	0.0% to 100.0%
FM (Frequency Modulation)	
Carrier waveforms	Sine, Square, Ramp, and Arbitrary
Modulation source	Internal or External
Internal modulating waveforms	Sine, Square, Ramp, Noise, and Arbitrary
Internal modulating frequency	2 mHz to 20.0 kHz
Frequency Deviation	Deviation ≤ Highest frequency of carrier waveform - Carrier waveform frequency
AFG1022	2 mHz to 12.5 MHz
AFG1062	2 mHz to 30 MHz

## Specifications

**Table 10: Modulation (cont.)**

Characteristic	Description
<b>PM (Phase Modulation)</b>	
Carrier waveforms	Sine, Square, Ramp, and Arbitrary
Modulation source	Internal or External
Internal modulating waveforms	Sine, Square, Ramp, Noise, and Arbitrary
Internal modulating frequency	2 MHz to 20.0 kHz
Phase deviation range	0.0° to 180.0°
<b>PWM (Pulse Width Modulation) (AFG1062 only)</b>	
Carrier waveforms	Pulse, $\leq 1$ MHz
Modulation source	Internal or External
Internal modulating waveforms	Sine, Square, Ramp, and Arbitrary
Internal modulating frequency	2 MHz to 20.0 kHz
Deviation range	0.0% to 50.0% of pulse period
<b>FSK (Frequency Shift Keying)</b>	
Carrier waveforms	Sine, Square, Ramp, and Arbitrary
Modulation source	Internal or External
Internal key rate	2 MHz to 100.0 kHz
Internal Modulating Waveforms	50% duty cycle square
<b>ASK (Amplitude Shift Keying) (AFG1062 only)</b>	
Carrier waveforms	Sine, Square, Ramp, and Arbitrary
Modulation source	Internal or External
Internal key rate	2 MHz to 100.0 kHz
Internal Modulating Waveforms	50% duty cycle square
<b>PSK (Phase Shift Keying) (AFG1062 only)</b>	
Carrier waveforms	Sine, Square, Ramp, and Arbitrary
Modulation source	Internal or External
Internal key rate	2 MHz to 100.0 kHz
Internal Modulating Waveforms	50% duty cycle square
<b>Sweep</b>	
Carrier waveforms	Sine, Square, Ramp and Arb
Type	Linear or Logarithmic
Min start/stop frequency	1 $\mu$ Hz
Max start/stop frequency	
AFG1022	Sine: 25 MHz Square: 12.5 MHz Ramp: 1 MHz
AFG1062	Sine: 60 MHz Square: 30 MHz Ramp: 2 MHz

Table 10: Modulation (cont.)

Characteristic	Description
Sweep time	1 ms to 500 s $\pm$ 0.1%
Direction	Up / Down
Trigger Source	Internal, External, or Manual
Burst	
Waveforms	Sine, Square, Ramp, Pulse, and Arbitrary
Burst count	
AFG1022	1 to 50,000 cycles, infinite or gated
AFG1062	1 to 1,000,000 cycles, infinite or gated
Start Phase	-360° to +360°
Trigger Sources	Internal, External, or Manual
Internal trigger interval	(40 ns - 500 s) $\pm$ 1% Min = Cycles * Period
Gate Source	External Trigger

## Input and output specifications

Table 11: Front panel

Characteristic	Description
External Reference Clock Output	
Frequency	10 MHz
Impedance	50 $\Omega$ , DC coupled
Amplitude	1.6 V <sub>p-p</sub> into 50 $\Omega$ load
External Trigger input	
Level	TTL compatible
Pulse width	>100 ns
Slope	Rising or falling (selectable)

Table 12: Rear panel

Characteristic	Description
External modulation input	
Input range	$\pm$ 1.0 V full scale (except FSK) 3.3 V logic level (FSK)
Impedance	12 k $\Omega$ (typical)
Frequency range	DC to 20 kHz
External Reference Clock Input (shared with Counter input)	
Impedance	400 $\Omega$ , AC coupled
Required input voltage swing	100 mV <sub>p-p</sub> to 5 V <sub>p-p</sub>
Lock range	10 MHz $\pm$ 9 kHz

## General specifications

Table 13: Power

Characteristic	Description
Source voltage and frequency	220 - 240 VAC, 100 - 120 VAC, 50/60 Hz, CAT II
Power consumption	
AFG1022	Less than 28 W
AFG1062	Less than 35 W
Fuse	110 V: 250 V, F1AL 220 V: 250 V, F0.5AL

Table 14: Export control

Characteristic	Description
Effective analog bandwidth, typical	(Arbitrary waveform at 1 V <sub>p-p</sub> amplitude) 30 MHz
Effective maximum frequency out	10 MHz
Phase noise	(At 1 V <sub>p-p</sub> amplitude) At 20 MHz: < -110 dBc/Hz at 10 kHz offset

Table 15: Environmental

Characteristic	Description
Temperature range	
Operating	0 °C to 40 °C
Non operating	-20 °C to 60 °C
Humidity	
Operating	≤ 80%, non-condensing
Altitude	
Operating	Up to 3,000 meters ( apx. 9843 feet)
Non operating	Up to 12,000 meters (apx. 39,370 feet)
Cooling Method	Fan cooling

Table 16: System characteristics

Characteristic	Description
Warm-up time, typical	30 minutes minimum
Communication Interface	USB host (front panel) and device (rear panel)
Net weight	3.4 kg (7.5 lbs), approximate
Dimensions (overall)	
Height	111.16 mm (4.38 in)
Width	229.16 mm (9.02 in)
Depth	306.36 mm (12.06 in), including rear boot

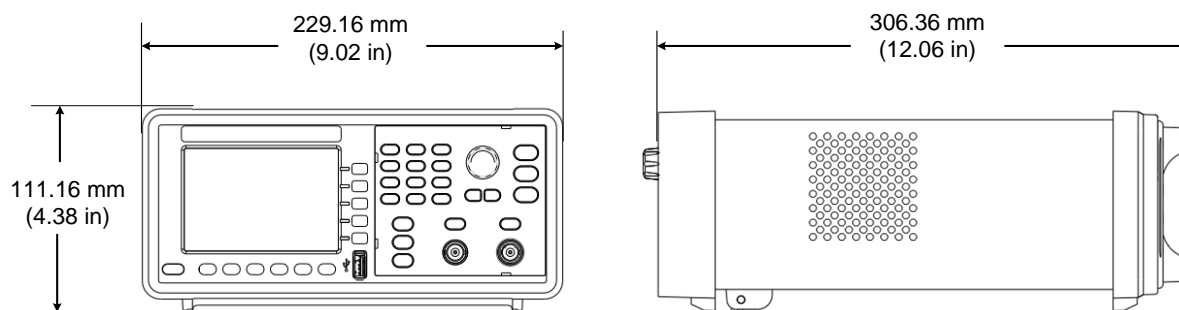

Figure 1: AFG1000 Series dimensions

# Performance tests

The Performance Tests include functional tests, such as the interface functional test in this manual.

- The Functional Tests verify the functions; they verify that the instrument features operate. They do not verify that they operate within limits.
- The Performance Tests verify that the instrument performs as warranted. The Performance Tests check all the characteristics that are designated as checked in Specifications.

Table 17: Performance test items

Titles	Test items	Reference Page
Frequency/Period Test	Internal clock output frequency accuracy	(See page 20, <i>Frequency/Period test.</i> )
Amplitude Test	Amplitude accuracy	(See page 21, <i>Amplitude test.</i> )
DC Offset Test	Amplitude accuracy	(See page 23, <i>DC offset test.</i> )
Counter Test	Frequency Resolution	(See page 24, <i>Counter test.</i> )
AC Flatness Test	AC Flatness	(See page 26, <i>AC flatness test.</i> )
Harmonic Distortion Test	Harmonic Distortion	(See page 28, <i>Harmonics distortion test.</i> )
THD (Total Harmonic Distortion) Test	Total Harmonic Distortion	(See page 30, <i>Total harmonic distortion test.</i> )

- Performance conditions** The tests in this section comprise an extensive, valid confirmation of performance and functionality when the following requirements are met:
- The cabinet covers must be on the Series.
  - The instrument must have been calibrated/adjusted at an ambient temperature between +20 °C and +30 °C.
  - The instrument must be operating at an ambient temperature between +0 °C and +40 °C.
  - The instrument must have had a warm-up period of at least 30 minutes.

**Equipment required** The following table lists the required equipment used to complete the performance tests.

Table 18: Test equipment

Description	Minimum requirements	Recommended equipment	Purpose
1. Digital Multi Meter (DMM)	AC volts, true rms, AC coupled Accuracy: $\pm 0.1\%$ to 1 kHz DC volts Accuracy: 50 ppm, resolution 100 $\mu\text{V}$ Resistance Accuracy: $\pm 0.05 \Omega$	Agilent 3458A	Measures voltage. Used in multiple procedures.
2. Power Meter	100 kHz to 250 MHz 1 $\mu\text{W}$ to 100 mW (-30 dBm to +20 dBm) Accuracy: 0.02 dB Resolution: 0.01 dB	R&S NRVS	Measures voltage. Used in multiple procedures.
3. Power Head	100 kHz to 250 MHz 1 $\mu\text{W}$ to 100 mW (-30 dBm to +20 dBm)	R&S NRV-Z51	Measures voltage. Used in multiple procedures.
4. Frequency Counter	Accuracy: 0.01 ppm Phase measurement	Agilent 53132A	Checks clock frequency.
5. Signal Generator	Sine 1 MHz, Pulse 1 MHz Frequency Accuracy: $\pm 1$ ppm	Tektronix AFG2021	Checks counter
6. Spectrum Analyzer	20 kHz to 1.25 GHz	Tektronix RSA3303A	Checks output signals. Harmonics Spurious.
7. BNC Coaxial Cable	50 $\Omega$ , male to male BNC connector, 91 cm	Tektronix part number 012-0482-00	Signal interconnection
8. BNC terminator	50 $\Omega$ , $\pm 1 \Omega$ , 2 W, DC to 1 GHz, BNC	Tektronix part number 011-0049-02	Signal termination
9. Attenuator	50 $\Omega$ , x10, BNC	Tektronix part number 011-0059-03	Signal attenuation

Table 18: Test equipment (cont.)

Description	Minimum requirements	Recommended equipment	Purpose
10. Adapter Dual-Banana Plug	BNC (female) to dual banana	Tektronix part number 103-0090-00	Signal interconnection to a DMM
11. Adapter BNC (female)-N (male)	BNC (female) to N (male)	Tektronix part number 103-0045-00	Signal interconnection to a Spectrum Analyzer

## Test record

Photocopy the test records and use them to record the performance test results for your instrument.



Table 19: Series Performance Test Record

Instrument Serial Number:	Certificate Number:
Temperature:	RH %:
Date of Calibration:	Technician:

## Frequency, Amplitude, DC Offset, Counter, and AC Flatness Test Record

Frequency	Minimum	Test result	Maximum
Sine at 1.000000 MHz	0.999999 MHz		1.000001 MHz
Pulse at 1.000000 MHz	0.999999 MHz		1.000001 MHz

## Amplitude

$$CF = 2 / (1 + 50 \Omega / \text{Measurement } \Omega) =$$

CH1 Amplitude	Minimum	Test result	Maximum
10 mVrms at 1.00 kHz	$(10 \times CF - 0.454)$ mVrms		$(10 \times CF + 0.454)$ mVrms
35 mVrms at 1.00 kHz	$(35 \times CF - 0.704)$ mVrms		$(35 \times CF + 0.704)$ mVrms
106 mVrms at 1.00 kHz	$(106 \times CF - 1.41)$ mVrms		$(106 \times CF + 1.41)$ mVrms
354 mVrms at 1.00 kHz	$(354 \times CF - 3.89)$ mVrms		$(354 \times CF + 3.89)$ mVrms
1.061 Vrms at 1.00 kHz	$(1.061 \times CF - 0.0110)$ Vrms		$(1.061 \times CF + 0.0110)$ Vrms
3.535 Vrms at 1.00 kHz	$(3.535 \times CF - 0.0357)$ Vrms		$(3.535 \times CF + 0.0357)$ Vrms
CH2 Amplitude	Minimum	Test result	Maximum
10 mVrms at 1.00 kHz	$(10 \times CF - 0.454)$ mVrms		$(10 \times CF + 0.454)$ mVrms
35 mVrms at 1.00 kHz	$(35 \times CF - 0.704)$ mVrms		$(35 \times CF + 0.704)$ mVrms
106 mVrms at 1.00 kHz	$(106 \times CF - 1.41)$ mVrms		$(106 \times CF + 1.41)$ mVrms
354 mVrms at 1.00 kHz	$(354 \times CF - 3.89)$ mVrms		$(354 \times CF + 3.89)$ mVrms
1.061 Vrms at 1.00 kHz	$(1.061 \times CF - 0.0110)$ Vrms		$(1.061 \times CF + 0.0110)$ Vrms
3.535 Vrms at 1.00 kHz	$(3.535 \times CF - 0.0357)$ Vrms		$(3.535 \times CF + 0.0357)$ Vrms

## DC Offset

$$CF = 2 / (1 + 50 \Omega / \text{Measurement } \Omega) =$$

CH1 DC Offset	Minimum	Test result	Maximum
+5.000 Vdc	$(+5.000 \times CF - 0.051)$ Vdc		$(+5.000 \times CF + 0.051)$ Vdc
+2.000 Vdc	$(+2.000 \times CF - 0.021)$ Vdc		$(+2.000 \times CF + 0.021)$ Vdc
+1.000 Vdc	$(+1.000 \times CF - 0.011)$ Vdc		$(+1.000 \times CF + 0.011)$ Vdc
0.000 Vdc	-0.001 Vdc		+0.001 Vdc
-1.000 Vdc	$(-1.000 \times CF - 0.011)$ Vdc		$(-1.000 \times CF + 0.011)$ Vdc
-2.000 Vdc	$(-2.000 \times CF - 0.021)$ Vdc		$(-2.000 \times CF + 0.021)$ Vdc
-5.000 Vdc	$(-5.000 \times CF - 0.051)$ Vdc		$(-5.000 \times CF + 0.051)$ Vdc

## Performance tests

### Frequency, Amplitude, DC Offset, Counter, and AC Flatness Test Record (cont.)

CH2 DC Offset	Minimum	Test result	Maximum
+5.000 Vdc	$(+5.000 \times CF - 0.051) \text{ Vdc}$		$(+5.000 \times CF + 0.051) \text{ Vdc}$
+2.000 Vdc	$(+2.000 \times CF - 0.021) \text{ Vdc}$		$(+2.000 \times CF + 0.021) \text{ Vdc}$
+1.000 Vdc	$(+1.000 \times CF - 0.011) \text{ Vdc}$		$(+1.000 \times CF + 0.011) \text{ Vdc}$
0.000 Vdc	-0.001 Vdc		+0.001 Vdc
-1.000 Vdc	$(-1.000 \times CF - 0.011) \text{ Vdc}$		$(-1.000 \times CF + 0.011) \text{ Vdc}$
-2.000 Vdc	$(-2.000 \times CF - 0.021) \text{ Vdc}$		$(-2.000 \times CF + 0.021) \text{ Vdc}$
-5.000 Vdc	$(-5.000 \times CF - 0.051) \text{ Vdc}$		$(-5.000 \times CF + 0.051) \text{ Vdc}$

### Counter

Frequency	Minimum	Test result	Maximum
Sine at 1.000000 MHz	999.990 kHz		1.00009 MHz
Pulse at 1.000000 MHz	999.990 kHz		1.00009 MHz

### AC Flatness (AFG1022)

CH1 AC Flatness	Minimum	Test result	Maximum
Frequency 1.00 kHz (Ampl: 1.000 V <sub>p-p</sub> )	-----	dB ( = Reference)	-----
Frequency 500.00 kHz	Reference - 0.40 dB		dB Reference + 0.40 dB
Frequency 1.00 MHz	Reference - 0.40 dB		dB Reference + 0.40 dB
Frequency 5.00 MHz	Reference - 0.40 dB		dB Reference + 0.40 dB
Frequency 15.00 MHz	Reference - 0.70 dB		dB Reference + 0.70 dB
Frequency 25.00 MHz	Reference - 0.70 dB		dB Reference + 0.70 dB
CH2 AC Flatness	Minimum	Test result	Maximum
Frequency 1.00 kHz (Ampl: 1.000 V <sub>p-p</sub> )	-----	dB ( = Reference)	-----
Frequency 500.00 kHz	Reference - 0.40 dB		dB Reference + 0.40 dB
Frequency 1.00 MHz	Reference - 0.40 dB		dB Reference + 0.40 dB
Frequency 5.00 MHz	Reference - 0.40 dB		dB Reference + 0.40 dB
Frequency 15.00 MHz	Reference - 0.70 dB		dB Reference + 0.70 dB
Frequency 25.00 MHz	Reference - 0.70 dB		dB Reference + 0.70 dB

### AC Flatness (AFG1062)

CH1 AC Flatness	Minimum	Test result	Maximum
Frequency 1.00 kHz (Ampl: 1.000 V <sub>p-p</sub> )	-----	dB ( = Reference)	-----
Frequency 100.00 kHz	Reference - 0.50 dB		dB Reference + 0.50 dB
Frequency 1.00 MHz	Reference - 0.50 dB		dB Reference + 0.50 dB
Frequency 5.00 MHz	Reference - 0.50 dB		dB Reference + 0.50 dB
Frequency 15.00 MHz	Reference - 0.90 dB		dB Reference + 0.90 dB
Frequency 25.00 MHz	Reference - 0.90 dB		dB Reference + 0.90 dB
Frequency 60.00 MHz	Reference - 0.90 dB		dB Reference + 0.90 dB

## Frequency, Amplitude, DC Offset, Counter, and AC Flatness Test Record (cont.)

CH2 AC Flatness	Minimum	Test result	Maximum
Frequency 1.00 kHz (Ampl: 1.000 V <sub>p-p</sub> )	-----	dB (= Reference)	-----
Frequency 500.00 kHz	Reference - 0.50 dB		dB Reference + 0.50 dB
Frequency 1.00 MHz	Reference - 0.50 dB		dB Reference + 0.50 dB
Frequency 5.00 MHz	Reference - 0.50 dB		dB Reference + 0.50 dB
Frequency 15.00 MHz	Reference - 0.90 dB		dB Reference + 0.90 dB
Frequency 25.00 MHz	Reference - 0.90 dB		dB Reference + 0.90 dB
Frequency 60.00 MHz	Reference - 0.90 dB		dB Reference + 0.90 dB

## Harmonic Distortion Test Record

Harmonic Distortion	Fundamental = reference	2nd	3rd	4th	5th	Limit
<b>AFG1022</b> Spectrum Analyzer reading						
Sine 20 kHz	20 kHz	40 kHz	60 kHz	80 kHz	100 kHz	
CH1 Harmonic Distortion	dBc	dBc	dBc	dBc	dBc	
reading - reference	0 dBc	dBc	dBc	dBc	dBc	Nth - reference < -50 dBc
CH2 Harmonic Distortion	dBc	dBc	dBc	dBc	dBc	
reading - reference	0 dBc	dBc	dBc	dBc	dBc	Nth - reference < -50 dBc
Sine 100 kHz	100 kHz	200 kHz	300 kHz	400 kHz	500 kHz	
CH1 Harmonic Distortion	dBc	dBc	dBc	dBc	dBc	
reading - reference	0 dBc	dBc	dBc	dBc	dBc	Nth - reference < -50 dBc
CH2 Harmonic Distortion	dBc	dBc	dBc	dBc	dBc	
reading - reference	0 dBc	dBc	dBc	dBc	dBc	Nth - reference < -50 dBc
Sine 1 MHz	1 MHz	2 MHz	3 MHz	4 MHz	5 MHz	
CH1 Harmonic Distortion	dBc	dBc	dBc	dBc	dBc	
reading - reference	0 dBc	dBc	dBc	dBc	dBc	Nth - reference < -50 dBc
CH2 Harmonic Distortion	dBc	dBc	dBc	dBc	dBc	
reading - reference	0 dBc	dBc	dBc	dBc	dBc	Nth - reference < -50 dBc
Sine 25 MHz	25 MHz	50 MHz	75 MHz	100 MHz	125 MHz	
CH1 Harmonic Distortion	dBc	dBc	dBc	dBc	dBc	
reading - reference	0 dBc	dBc	dBc	dBc	dBc	Nth - reference < -50 dBc
CH2 Harmonic Distortion	dBc	dBc	dBc	dBc	dBc	
reading - reference	0 dBc	dBc	dBc	dBc	dBc	Nth - reference < -50 dBc

## Performance tests

AFG1062		Spectrum Analyzer reading					
Sine 20 kHz	20 kHz	40 kHz	60 kHz	80 kHz	100 kHz		
CH1 Harmonic Distortion	dBc	dBc	dBc	dBc	dBc		
reading - reference	0 dBc	dBc	dBc	dBc	dBc	dBc	Nth - reference < -60 dBc
CH2 Harmonic Distortion	dBc	dBc	dBc	dBc	dBc		
reading - reference	0 dBc	dBc	dBc	dBc	dBc	dBc	Nth - reference < -60 dBc
Sine 100 kHz	100 kHz	200 kHz	300 kHz	400 kHz	500 kHz		
CH1 Harmonic Distortion	dBc	dBc	dBc	dBc	dBc		
reading - reference	0 dBc	dBc	dBc	dBc	dBc	dBc	Nth - reference < -60 dBc
CH2 Harmonic Distortion	dBc	dBc	dBc	dBc	dBc		
reading - reference	0 dBc	dBc	dBc	dBc	dBc	dBc	Nth - reference < -60 dBc
Sine 1 MHz	1 MHz	2 MHz	3 MHz	4 MHz	5 MHz		
CH1 Harmonic Distortion	dBc	dBc	dBc	dBc	dBc		
reading - reference	0 dBc	dBc	dBc	dBc	dBc	dBc	Nth - reference < -60 dBc
CH2 Harmonic Distortion	dBc	dBc	dBc	dBc	dBc		
reading - reference	0 dBc	dBc	dBc	dBc	dBc	dBc	Nth - reference < -60 dBc
Sine 25 MHz	25 MHz	50 MHz	75 MHz	100 MHz	125 MHz		
CH1 Harmonic Distortion	dBc	dBc	dBc	dBc	dBc		
reading - reference	0 dBc	dBc	dBc	dBc	dBc	dBc	Nth - reference < -47 dBc
CH2 Harmonic Distortion	dBc	dBc	dBc	dBc	dBc		
reading - reference	0 dBc	dBc	dBc	dBc	dBc	dBc	Nth - reference < -47 dBc
Sine 60 MHz	60 MHz	120 MHz	180 MHz	240 MHz	300 MHz		
CH1 Harmonic Distortion	dBc	dBc	dBc	dBc	dBc		
reading - reference	0 dBc	dBc	dBc	dBc	dBc	dBc	Nth - reference < -47 dBc
CH2 Harmonic Distortion	dBc	dBc	dBc	dBc	dBc		
reading - reference	0 dBc	dBc	dBc	dBc	dBc	dBc	Nth - reference < -47 dBc

## Total Harmonic Distortion (THD) Test Record

## Spectrum Analyzer reading

	Fundamental = reference	2nd	3rd	4th	5th	6th	7th
Sine 20.0 kHz	20 kHz	40 kHz	60 kHz	80 kHz	100 kHz	120 kHz	140 kHz
CH1 reading (dBm)	A <sub>1</sub> =	A <sub>2</sub> =	A <sub>3</sub> =	A <sub>4</sub> =	A <sub>5</sub> =	A <sub>6</sub> =	A <sub>7</sub> =
reading - reference (A <sub>n</sub> - A <sub>1</sub> ) (dBc)	B <sub>1</sub> = 0	B <sub>2</sub> =	B <sub>3</sub> =	B <sub>4</sub> =	B <sub>5</sub> =	B <sub>6</sub> =	B <sub>7</sub> =
$C_n = 10^{B_n/20}$	C <sub>1</sub> = 1	C <sub>2</sub> =	C <sub>3</sub> =	C <sub>4</sub> =	C <sub>5</sub> =	C <sub>6</sub> =	C <sub>7</sub> =
$THD = \frac{\sqrt{\sum_{n=2} C_n^2}}{C_1}$							Limit < 0.2%
CH2 reading (dBm)	A <sub>1</sub> =	A <sub>2</sub> =	A <sub>3</sub> =	A <sub>4</sub> =	A <sub>5</sub> =	A <sub>6</sub> =	A <sub>7</sub> =
reading - reference (A <sub>n</sub> - A <sub>1</sub> ) (dBc)	B <sub>1</sub> = 0	B <sub>2</sub> =	B <sub>3</sub> =	B <sub>4</sub> =	B <sub>5</sub> =	B <sub>6</sub> =	B <sub>7</sub> =
$C_n = 10^{B_n/20}$	C <sub>1</sub> = 1	C <sub>2</sub> =	C <sub>3</sub> =	C <sub>4</sub> =	C <sub>5</sub> =	C <sub>6</sub> =	C <sub>7</sub> =
$THD = \frac{\sqrt{\sum_{n=2} C_n^2}}{C_1}$							Limit < 0.2%

## Frequency/Period test

This test verifies the frequency accuracy of the instrument. All output frequencies are derived from a single generated frequency. Only one frequency point of channel 1 is required to be checked.

1. Connect the arbitrary function generator to the frequency counter as shown in the following figure.

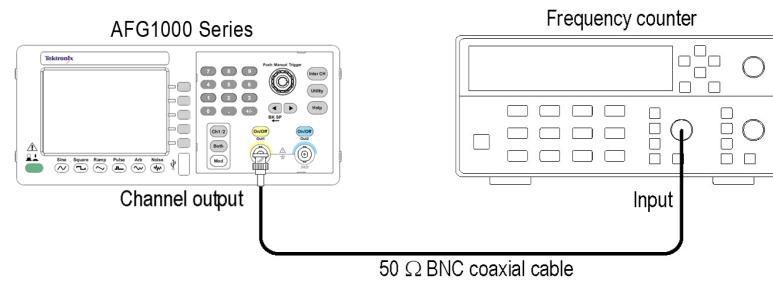

Figure 2: Frequency/Period tests

2. Push the following buttons to recall the arbitrary function generator default setup:  
**Utility > System > Set to Default.**
3. Set up the arbitrary function generator as follows:
  - a. Push the **Sine** button on the front panel.
  - b. Press the **Freq/Period** bezel button to choose **Freq.** The chosen parameter will be lighted with white background.
  - c. Use the numeric keypad or the general purpose knob to set the frequency to 1 MHz.
  - d. Press the **Ampl/High** bezel button to choose **Ampl.** The chosen parameter will be lighted with white background.
  - e. Use the numeric keypad or the general purpose knob to set the amplitude to 1.000 V<sub>p-p</sub>.
  - f. Check that the CH1 **On/Off** front panel button LED is on. If not, then the channel output is off. Push the CH1 **On/Off** button to turn it on.
4. Check that reading of the Frequency Counter is between 0.999999 MHz and 1.000001 MHz.

5. Push the **Pulse** button on the front panel.
6. Check that reading of the Frequency Counter is between 0.999999 MHz and 1.000001 MHz.

## Amplitude test

This test verifies the amplitude accuracy of the arbitrary function generator. All output amplitudes are derived from a combination of attenuators and 3 dB variable gain. Some amplitude points are checked. This test uses a 50  $\Omega$  terminator. It is necessary to know the accuracy of the 50  $\Omega$  terminator in advance of this amplitude test. This accuracy is used as a calibration factor.

1. Connect the 50  $\Omega$  terminator to the DMM as shown in the following figure and measure the register value.

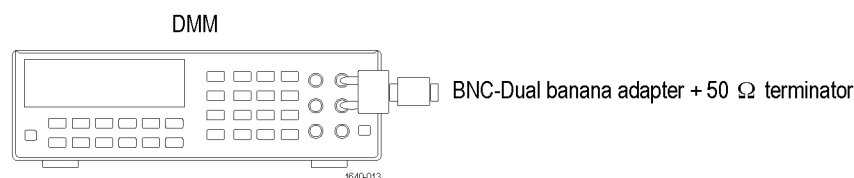

Figure 3: 50  $\Omega$  terminator accuracy

2. Calculate the 50  $\Omega$  calibration factor (CF) from the reading value and record as follows:

$$CF \text{ (Calibration Factor)} = 2 / (1 + 50 \Omega / \text{Measurement } \Omega)$$

Measurement (reading of the DMM) $\Omega$	CF
Examples	
50.50 $\Omega$	1.0050 (= 2 / (1 + 50 / 50.50))
49.62 $\Omega$	0.9962 (= 2 / (1 + 50 / 49.62))

3. Connect the arbitrary function generator to the DMM as shown in the following figure. Be sure to connect the 50 Ω terminator to the arbitrary function generator Output connector side.

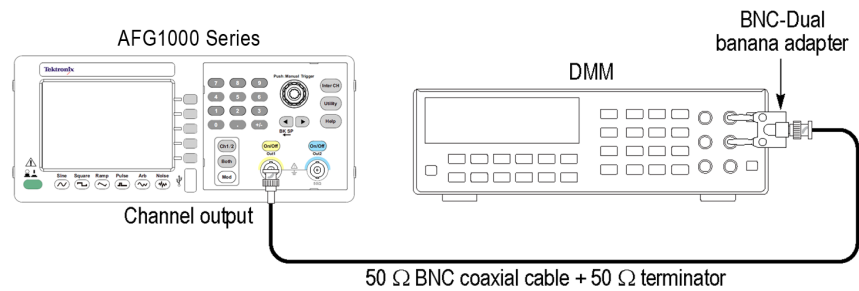

Figure 4: Amplitude tests

4. Set up the arbitrary function generator as follows:
  - a. Push the **Sine** button on the front panel.
  - b. Press the **Freq/Period** bezel button to choose **Freq**. The chosen parameter will be lighted with white background.
  - c. Use the numeric keypad or the general purpose knob to set the frequency to 1 kHz.
  - d. Press the **Ampl/High** bezel button to choose **Ampl**. The chosen parameter will be lighted with white background.
  - e. Check that the CH1 **On/Off** front panel button LED is on. If not, then the channel output is off. Push the CH1 **On/Off** button to turn it on.
5. Verify that each amplitude measurement is within the range specified in the following table. Take care to choose **mVrms** or **Vrms** as the voltage unit.
6. Repeat steps 3 through 5 for the channel 2 output.

Function	Frequency	Amplitude	Measurement	Range
Sine	1.000 kHz	10 mVrms	mVrms	$(10 \times CF \pm 0.454)$ mVrms
Sine	1.000 kHz	35 mVrms	mVrms	$(35 \times CF \pm 0.704)$ mVrms
Sine	1.000 kHz	106 mVrms	mVrms	$(106 \times CF \pm 1.41)$ mVrms
Sine	1.000 kHz	354 mVrms	mVrms	$(354 \times CF \pm 3.89)$ mVrms
Sine	1.000 kHz	1.061 Vrms	Vrms	$(1.061 \times CF \pm 0.0110)$ Vrms
Sine	1.000 kHz	3.535 Vrms	Vrms	$(3.535 \times CF \pm 0.0357)$ Vrms



## DC offset test

This test verifies the DC offset accuracy of the arbitrary function generator. This test uses a 50  $\Omega$  terminator. It is necessary to know the accuracy of a 50  $\Omega$  terminator in advance of this test. This accuracy is used as a calibration factor.

1. Connect the 50  $\Omega$  terminator to the DMM as shown in the following figure and measure the register value.

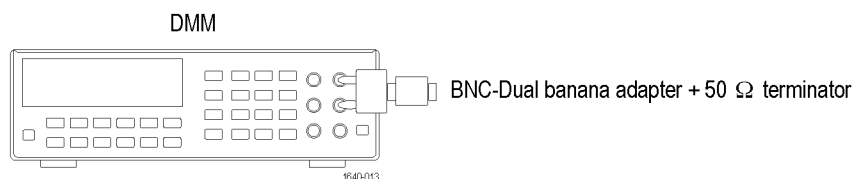

Figure 5: 50  $\Omega$  terminator accuracy

2. Calculate the 50  $\Omega$  calibration factor (CF) from the reading value and record as follows:

$$CF (\text{Calibration Factor}) = 2 / (1 + 50 \Omega / \text{Measurement } \Omega)$$

Measurement (reading of the DMM) $\Omega$	CF
Examples	
50.50 $\Omega$	1.0050 (= 2 / (1 + 50 / 50.50))
49.62 $\Omega$	0.9962 (= 2 / (1 + 50 / 49.62))

3. Connect the arbitrary function generator to the DMM as shown in the following figure. Be sure to connect the 50  $\Omega$  terminator to the arbitrary function generator Output connector side.

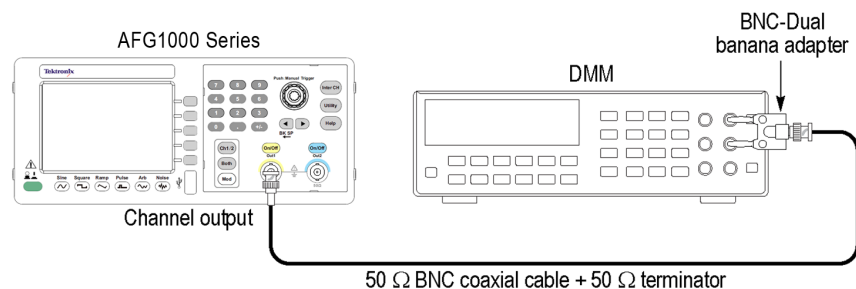

Figure 6: DC offset tests

4. Set up the arbitrary function generator as follows:
  - a. Push the **Arb** waveform button on the front panel.

- b. Press the **Others** bezel button.
  - c. Press the **Built\_in** bezel button, then **Others** bezel button. Select **DC**.
  - d. Press the **Offset/Low** bezel button to choose **Offset**. The chosen parameter will be lighted with white background.
  - e. Use the numeric keypad or the general purpose knob to set the offset value.
  - f. Check that the CH1 **On/Off** front panel button LED is on. If not, then the channel output is off. Push the CH1 **On/Off** button to turn it on.
5. Verify that each offset measurement is within the range specified in the following table.
  6. Repeat steps 3 through 5 for the channel 2 output.

Function	Offset	Measurement	Range
DC	+ 5.000 Vdc	Vdc	$(5.000 \times CF \pm 0.051) \text{ Vdc}$
DC	+ 2.000 Vdc	Vdc	$(2.000 \times CF \pm 0.021) \text{ Vdc}$
DC	+ 1.000 Vdc	Vdc	$(1.000 \times CF \pm 0.011) \text{ Vdc}$
DC	0.000 Vdc	Vdc	$\pm 0.001 \text{ Vdc}$
DC	- 1.000 Vdc	Vdc	$(- 1.000 \times CF \pm 0.011) \text{ Vdc}$
DC	- 2.000 Vdc	Vdc	$(- 2.000 \times CF \pm 0.021) \text{ Vdc}$
DC	- 5.000 Vdc	Vdc	$(- 5.000 \times CF \pm 0.051) \text{ Vdc}$

## Counter test

This test verifies the frequency counter accuracy of the instrument. Only one frequency point is required to be checked.

1. Connect the **Ref Clk/Counter In** connector on the rear panel of the AFG1000 Series to the AFG2021 signal generator as shown in the following figure.

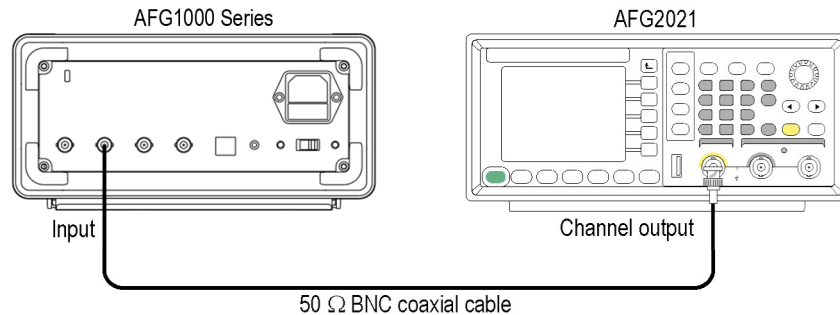



Figure 7: Counter tests

2. Push the following buttons to recall the AFG1000 Series default setup:  
**Utility > System > Set to Default.**
3. Push the following buttons to enter the frequency counter function of AFG1000 Series:  
**Utility > Counter.**
4. Set up the AFG2021 signal generator as follows:
  - a. Push the **Sine** button on the front panel
  - b. Press the **Frequency/Period/Phase Menu** bezel button.
  - c. Press the **Frequency** bezel button (it will turn dark when activated) and use the numeric keypad or the general purpose knob to set the frequency to 1.000000 MHz.
  - d. Push the  button on the front panel to return to the top menu.
  - e. Press the **Amplitude/Level Menu** bezel button.
  - f. Press the **Amplitude** bezel button (it will turn dark when activated) and use the numeric keypad or the general purpose knob to set the amplitude to 1.000 V<sub>p-p</sub>.
  - g. Check that the **Channel On/Off** front panel button LED is on. If not, then the channel output is off. Push the **Channel On/Off** button to turn it on.
5. Check that reading of the frequency counter of AFG1000 Series is between 999.990 kHz and 1.00009 MHz.
6. Push the **Pulse** button on the front panel of AFG2021.
7. Check that reading of the frequency counter of AFG1000 Series is between 999.990 kHz and 1.00009 MHz.

## AC flatness test

This test verifies the flatness of a sine wave to 1 kHz sine wave.

1. Connect the arbitrary function generator to the DMM as shown in the following figure. Be sure to connect the 50  $\Omega$  terminator to the arbitrary function generator Output connector side. Use the same CF on page 21 (Amplitude test).

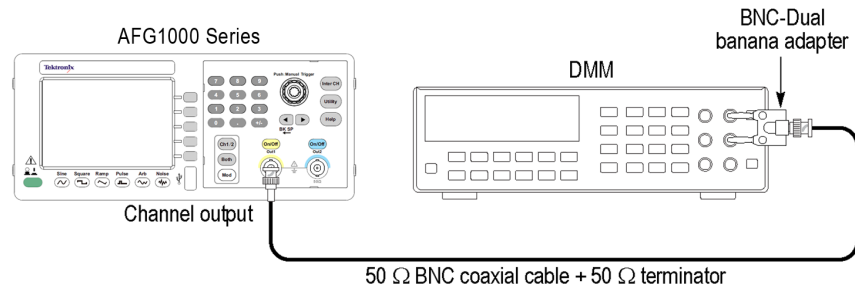

Figure 8: AC flatness tests for 1 kHz

2. Set up the arbitrary function generator as follows:
  - a. Push the **Sine** button on the front panel.
  - b. Press the **Freq/Period** bezel button to choose **Freq**. The chosen parameter will be lighted with white background.
  - c. Use the numeric keypad or the general purpose knob to set the frequency to 1 kHz.
  - d. Press the **Ampl/High** bezel button to choose **Ampl**. The chosen parameter will be lighted with white background.
  - e. Use the numeric keypad or the general purpose knob to set the amplitude to 1.000 V<sub>p-p</sub>.
  - f. Check that the CH1 **On/Off** front panel button LED is on. If not, then the channel output is off. Push the CH1 **On/Off** button to turn it on.
3. Read DMM V<sub>rms</sub> value, convert V<sub>rms</sub> to dbm by

$$\text{Power}(\text{dbm}) = 10 * \lg(20(\text{V}_{\text{rms}}/\text{CF})^2)$$

4. Write the converted dbm value of the 1 kHz sine wave as a reference power value.
5. Connect the arbitrary function generator to the power meter with a power head as shown in the following figure.

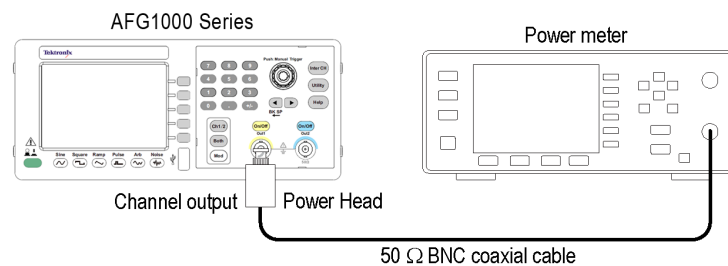

Figure 9: AC flatness tests for the frequency greater than 100 kHz

6. Set up the arbitrary function generator as follows:
  - a. Push the **Sine** button on the front panel.
  - b. Press the **Freq/Period** bezel button to choose **Freq**. The chosen parameter will be lighted with white background.
  - c. Use the numeric keypad or the general purpose knob to set the frequency to 500 kHz.
  - d. Press the **Ampl/High** bezel button to choose **Ampl**. The chosen parameter will be lighted with white background.
  - e. Use the numeric keypad or the general purpose knob to set the amplitude to 1.000 V<sub>p-p</sub>.
  - f. Check that the CH1 **On/Off** front panel button LED is on. If not, then the channel output is off. Push the CH1 **On/Off** button to turn it on.
7. Set the frequency of the Power Meter to 500 kHz.
8. Verify that the power measurement at each frequency is within the error specified in the following table.
9. Repeat steps 1 through 8 for the channel 2 output.

AFG1022		Measurement	Range
Function	Amplitude	(dB)	(dB)
Sine	+1.000 V <sub>p-p</sub>	= Reference	-----
Sine	+ 1.000 V <sub>p-p</sub>		Reference ± 0.40
Sine	+ 1.000 V <sub>p-p</sub>		Reference ± 0.40
Sine	+ 1.000 V <sub>p-p</sub>		Reference ± 0.40
Sine	+ 1.000 V <sub>p-p</sub>		Reference ± 0.70
Sine	+ 1.000 V <sub>p-p</sub>		Reference ± 0.70

AFG1062		Measurement	Range
Function	Amplitude	(dB)	(dB)
Sine	+1.000 V <sub>p-p</sub>	= Reference	-----
Sine	+ 1.000 V <sub>p-p</sub>		Reference ± 0.50
Sine	+ 1.000 V <sub>p-p</sub>		Reference ± 0.50
Sine	+ 1.000 V <sub>p-p</sub>		Reference ± 0.50
Sine	+ 1.000 V <sub>p-p</sub>		Reference ± 0.90
Sine	+ 1.000 V <sub>p-p</sub>		Reference ± 0.90
Sine	+ 1.000 V <sub>p-p</sub>		Reference ± 0.90

## Harmonics distortion test

This test verifies the harmonic distortion using a spectrum analyzer.

1. Connect the arbitrary function generator to the spectrum analyzer as shown in the following figure.

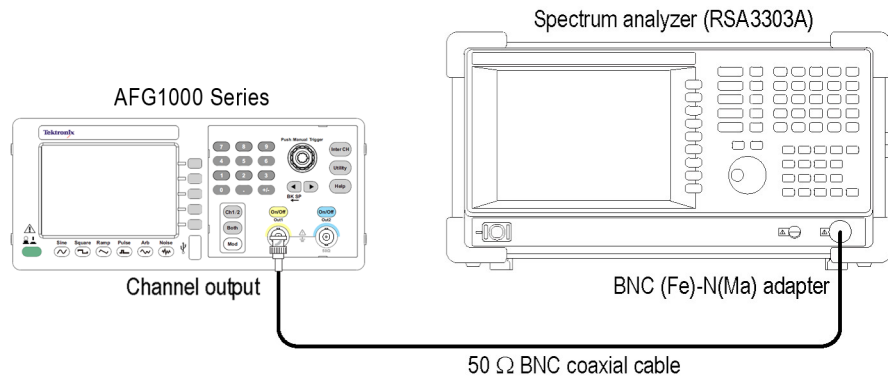

Figure 10: Harmonic distortion tests

2. Push the following buttons to recall the arbitrary function generator default setup:
  - Utility > System > Set to Default.**
3. Set up the arbitrary function generator as follows:
  - a. Push the **Sine** button on the front panel.
  - b. Press the **Freq/Period** bezel button to choose **Freq**. The chosen parameter will be lighted with white background.
  - c. Use the numeric keypad or the general purpose knob to set the frequency to 20.00 kHz.
  - d. Press the **Ampl/High** bezel button to choose **Ampl**. The chosen parameter will be lighted with white background.
  - e. Use the numeric keypad or the general purpose knob to set the amplitude to 1.000 V<sub>p-p</sub>.
  - f. Check that the CH1 **On/Off** front panel button LED is on. If not, then the channel output is off. Push the CH1 **On/Off** button to turn it on.

4. Set up the spectrum analyzer according the frequency setup of the arbitrary function generator.
5. Set the Ref Level of the spectrum analyzer to 8 dBm.
6. Read the signal level in the Fundamental frequency for each signal. Use this level as a Reference value in step 4.
7. Verify that the differences between the reference level and the signal level in the frequency of higher-order at each frequency are below the limit specified in the following table.
8. Repeat steps 1 through 7 for the channel 2 output.

AFG1022	Spectrum Analyzer			Measurement					Limit
	Frequency	Center Frequency	Span	RBW	Fundamental (= Reference)	2nd	3rd	4th	5th
20.00 kHz	100 kHz	200 kHz	500 Hz	20 kHz	40 kHz	60 kHz	80 kHz	100 kHz	< -50 dBc
100.00 kHz	500 kHz	1 MHz	2 kHz	100 kHz	200 kHz	300 kHz	400 kHz	500 kHz	< -50 dBc
1.00 MHz	5.00 MHz	10 MHz	20 kHz	1 MHz	2 MHz	3 MHz	4 MHz	5 MHz	< -50 dBc
25.00 MHz	125 MHz	250 MHz	20 kHz	25 MHz	50 MHz	75 MHz	100 MHz	125 MHz	< -50 dBc

AFG1062	Spectrum Analyzer			Measurement					Limit
	Frequency	Center Frequency	Span	RBW	Fundamental (= Reference)	2nd	3rd	4th	5th
20.00 kHz	100 kHz	200 kHz	500 Hz	20 kHz	40 kHz	60 kHz	80 kHz	100 kHz	< -60 dBc
100.00 kHz	500 kHz	1 MHz	2 kHz	100 kHz	200 kHz	300 kHz	400 kHz	500 kHz	< -60 dBc
1.00 MHz	5.00 MHz	10 MHz	20 kHz	1 MHz	2 MHz	3 MHz	4 MHz	5 MHz	< -60 dBc
25.00 MHz	125 MHz	250 MHz	20 kHz	25 MHz	50 MHz	75 MHz	100 MHz	125 MHz	< -47 dBc
60.00 MHz	250 MHz	500 MHz	20 kHz	60 MHz	120 MHz	180 MHz	240 MHz	300 MHz	< -47 dBc

## Total harmonic distortion test

This test verifies the total harmonic distortion (THD) using a spectrum analyzer.

1. Connect the arbitrary function generator to the spectrum analyzer as shown in the following figure.

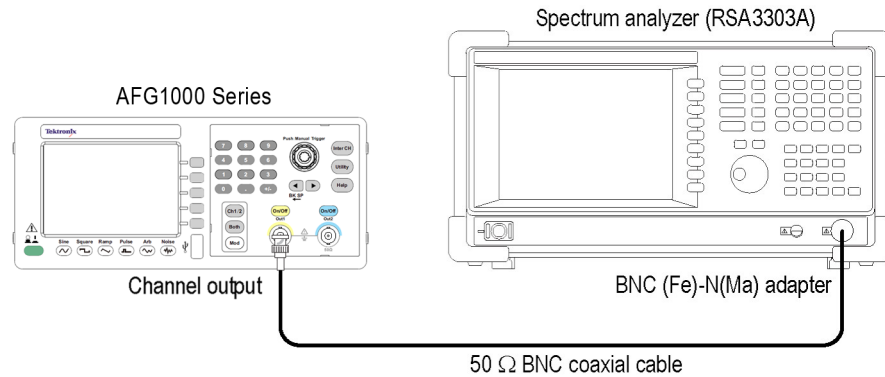

Figure 11: Total harmonic distortion tests

2. Set up the arbitrary function generator as follows:
  - a. Push the **Sine** button on the front panel.
  - b. Press the **Freq/Period** bezel button to choose **Freq**. The chosen parameter will be lighted with white background.
  - c. Use the numeric keypad or the general purpose knob to set the frequency to 20.00 kHz.
  - d. Press the **Ampl/High** bezel button to choose **Ampl**. The chosen parameter will be lighted with white background.
  - e. Use the numeric keypad or the general purpose knob to set the amplitude to 1.000 V<sub>p-p</sub>.
  - f. Check that the CH1 **On/Off** front panel button LED is on. If not, then the channel output is off. Push the CH1 **On/Off** button to turn it on.
3. Set up the spectrum analyzer according to the following table:

Center Frequency	Span	RBW
100 kHz	200 kHz	500 Hz

4. Set the Ref Level of the spectrum analyzer to 8 dBm.
5. When the THD cannot be measured directly, it is obtained by using the following calculation:

$$THD = \frac{\sqrt{\sum_{n=2} C_n^2}}{C_1}$$



6. Measure and record each level (A1 to A7) to the seventh harmonics of the 20 kHz sine wave.
7. Calculate the each B1 to B7, C1 to C7 value and the THD.

*NOTE: When all the harmonic components are -62 dBm or less, the calculation of THD can be skipped because it is THD < 0.2%.*

8. Verify that the THD is less than 0.2%.
9. Repeat steps 1 through 8 for the channel 2 output.

Function	Frequency	Measurement						
		Fundamental = reference	2nd	3rd	4th	5th	6th	7th
sine	20.00 kHz	20 kHz	40 kHz	60 kHz	80 kHz	100 kHz	120 kHz	140 kHz
reading (dBm)		A1 =	A2 =	A3 =	A4 =	A5 =	A6 =	A7 =
reading - reference An - A1 (dBc)		B1 = 0	B2 =	B3 =	B4 =	B5 =	B6 =	B7 =
Cn = 10 Bn/20		C1 = 1	C2 =	C3 =	C4 =	C5 =	C6 =	C7 =

	Measurement							
$THD = \frac{\sqrt{\sum_{n=2} C_n^2}}{C_1}$	THD =							Limit < 0.2%
Sample: reading	1.5 dBm	-58.5 dBm	-58.5 dBm	-63.5 dBm	-58.5 dBm	-63.5 dBm	-63.5 dBm	
reading - reference	0	-60 dBm	-60 dBm	-65 dBm	-60 dBm	-65 dBm	-65 dBm	
Cn =	1.000	0.001	0.001	0.000562	0.001	0.000562	0.000562	
$THD = \frac{\sqrt{\sum_{n=2} C_n^2}}{C_1}$	0.1987%							Limit < 0.2%