

# PROTOBARD ELEMENTOS PASIVOS MULTIMETRO



LABORATORIO 3  
1er cuatrimestre 2023

# Placa de prueba – Protoboard – Breadboard

- Zona de alimentación: columnas para conectar las fuentes de alimentación – No están conectadas entre sí – Están divididas en el medio
- Los orificios de las filas se encuentran conectados
- Las filas están divididas en el medio, hay dos zonas de conexiones para los elementos del circuito

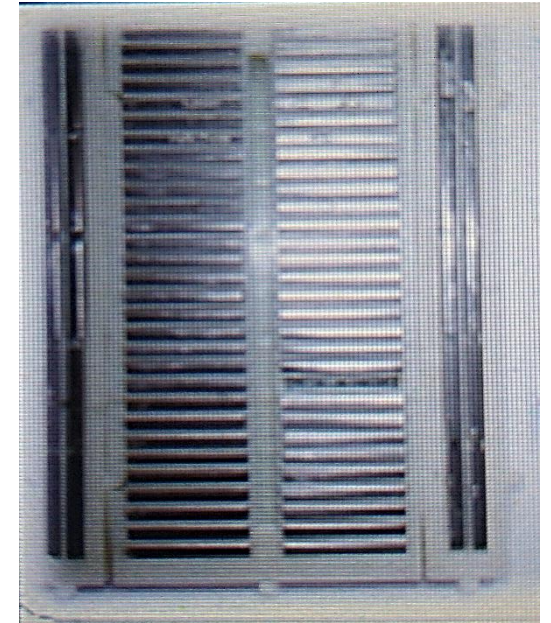
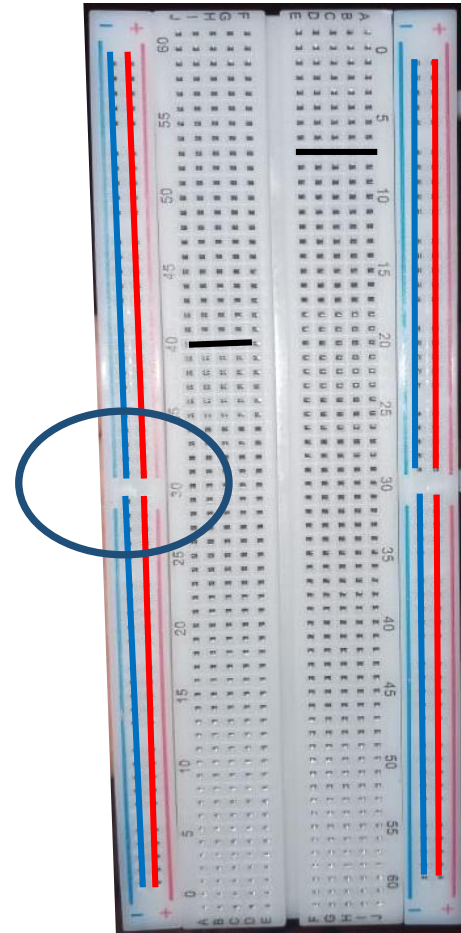

Las barras indican cómo están conectados los orificios

# Componentes electrónicos pasivos

- ❖ Solo pueden disipar o acumular/entregar energía.
- ❖ Solo requieren de la corriente que fluye en el circuito.
- ❖ No requieren de una fuente externa al circuito para funcionar como los elementos activos.

*Componente*

*Diagrama eléctrico*

*Componente real*

*Dibujo para esquema  
Arduino*

• Resistencia



• Capacitor

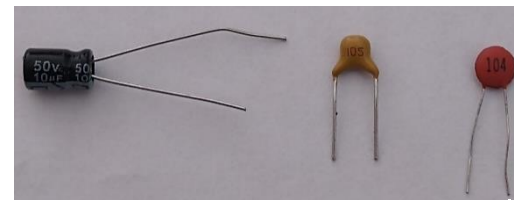
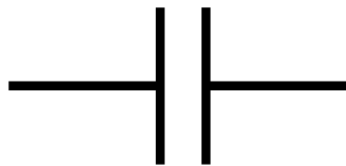

• Inductor



# Componentes electrónicos pasivos

*Componente*

*Diagrama eléctrico*

*Componente real*

*Dibujo para esquema  
Arduino*

- Diodo (LED)

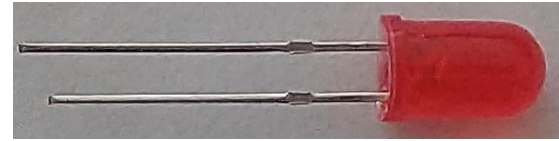
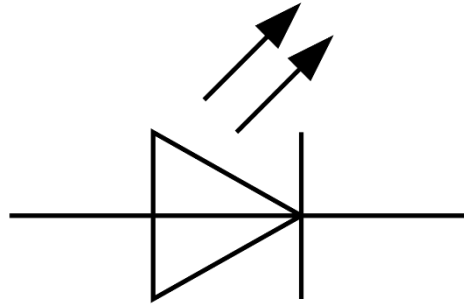

- Diodo rectificador

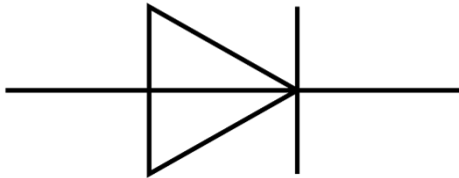

- Termistor

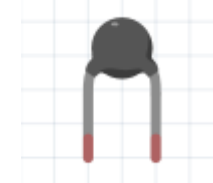
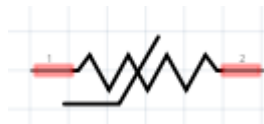

- Transformador

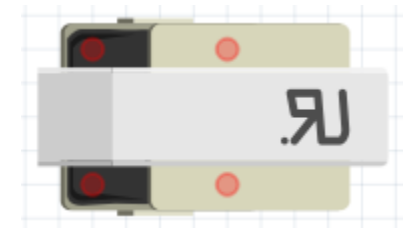
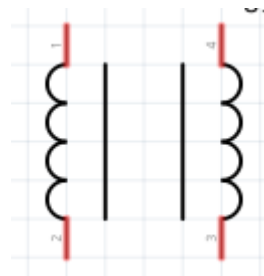

# Resistencias

## TIPOS DE RESISTENCIAS FIJAS

Resistencias de película de carbón



Resistencias metálicas:  
Alambre bobinado  
Película metálica  
Película de óxido metálico

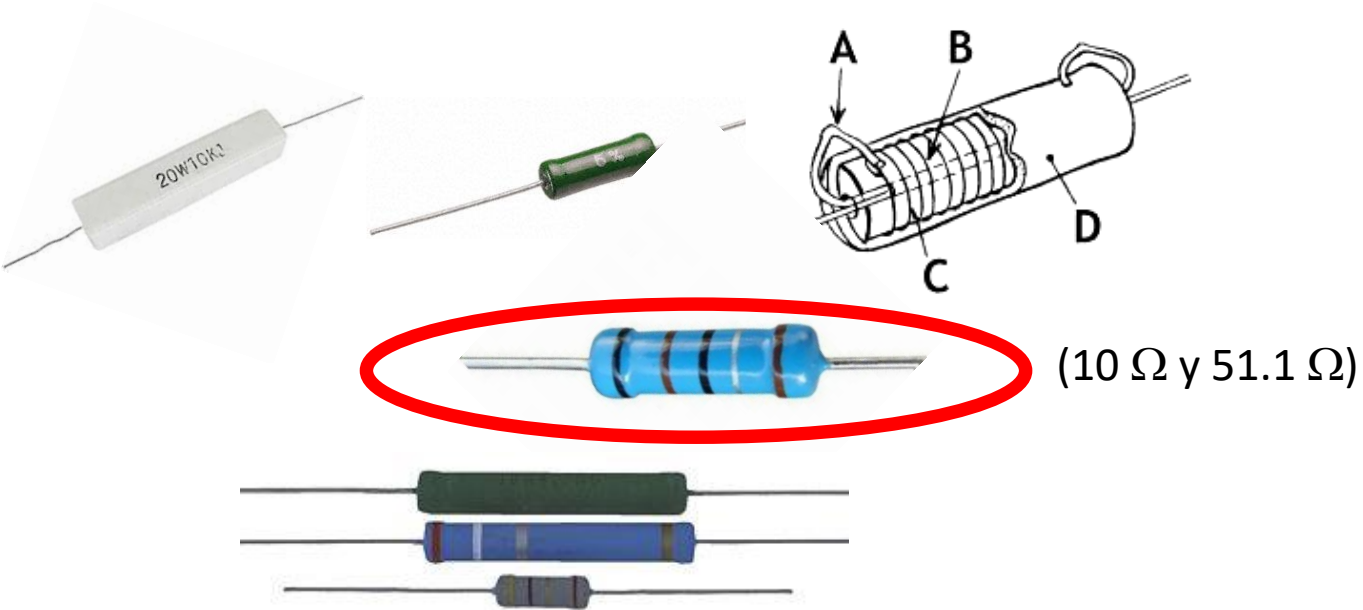

# CODIGO DE COLORES PARA LAS RESISTENCIAS

4-Band-Code

2%, 5%, 10%

560k  $\Omega$   $\pm$  5%

COLOR	1 <sup>ST</sup> BAND	2 <sup>ND</sup> BAND	3 <sup>RD</sup> BAND	MULTIPLIER	TOLERANCE
Black	0	0	0	1 $\Omega$	
Brown	1	1	1	10 $\Omega$	$\pm$ 1% (F)
Red	2	2	2	100 $\Omega$	$\pm$ 2% (G)
Orange	3	3	3	1K $\Omega$	
Yellow	4	4	4	10K $\Omega$	
Green	5	5	5	100K $\Omega$	$\pm$ 0.5% (D)
Blue	6	6	6	1M $\Omega$	$\pm$ 0.25% (C)
Violet	7	7	7	10M $\Omega$	$\pm$ 0.10% (B)
Grey	8	8	8	100M $\Omega$	$\pm$ 0.05%
White	9	9	9	1G $\Omega$	
Gold				0.1 $\Omega$	$\pm$ 5% (J)
Silver				0.01 $\Omega$	$\pm$ 10% (K)

5-Band-Code

0.1%, 0.25%, 0.5%, 1%

237  $\Omega$   $\pm$  1%

# Potencia máxima

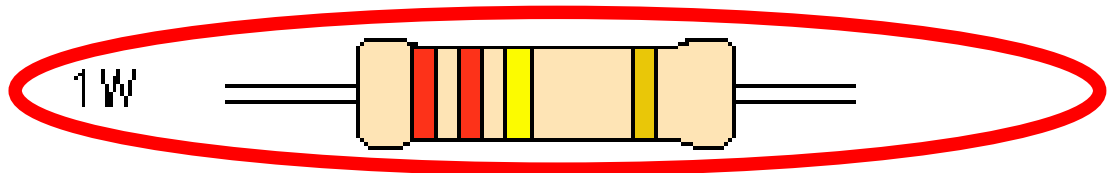
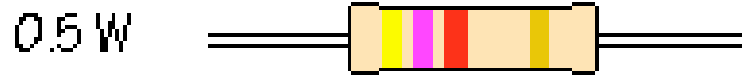
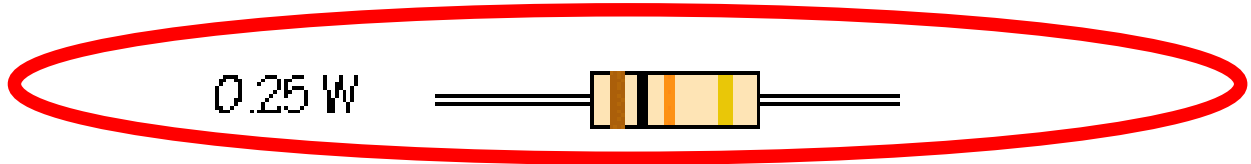

(10  $\Omega$  y 51.1  $\Omega$ )

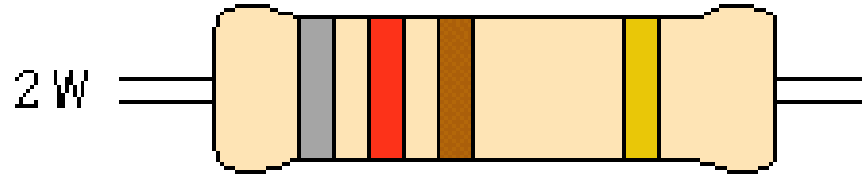

Mayor capacidad de disipar potencia



Mayor tamaño

# Potenciómetro

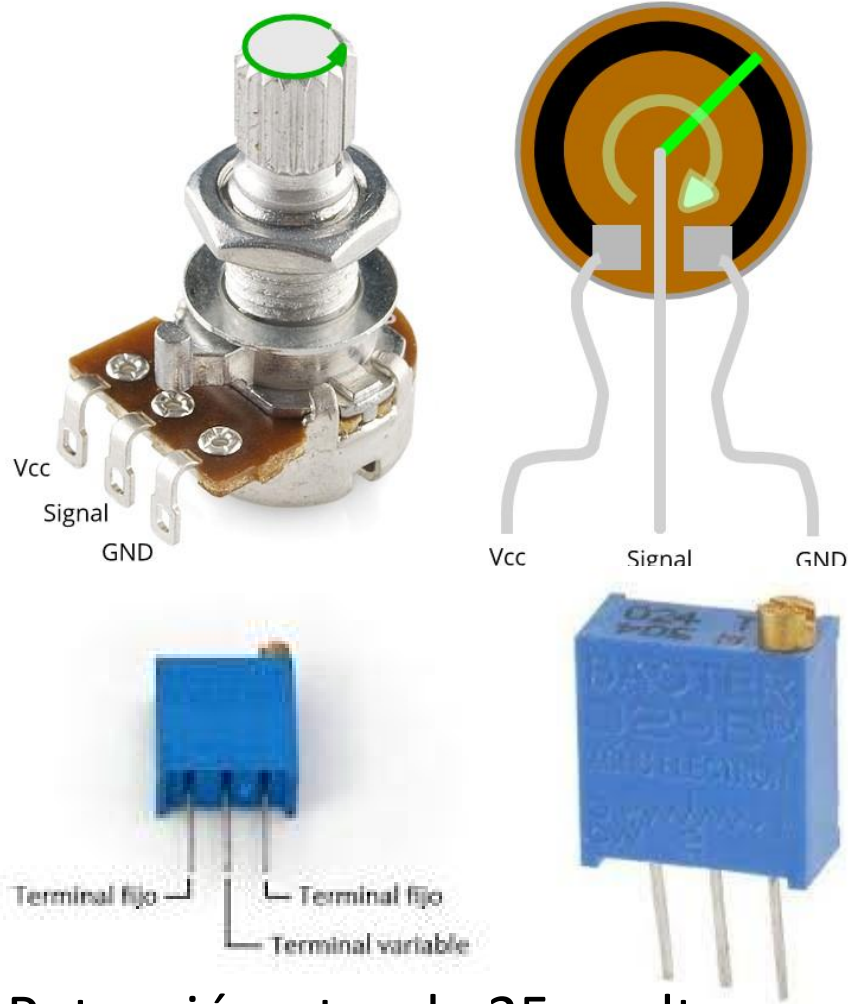

Potenciómetro de 25 vueltas

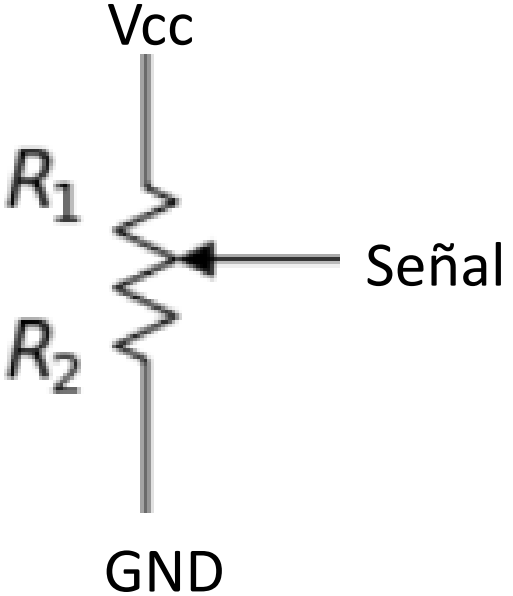
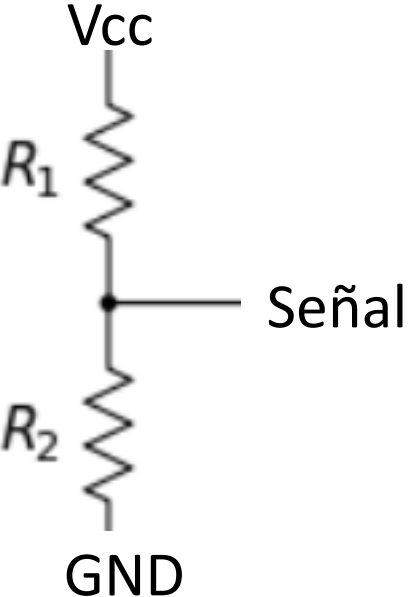
Diagrama circuital	Circuito efectivo
	

$$R_1 + R_2 = \text{constante}$$



# Multímetro digital

- Instrumento que permite medir:

- Resistencia
- Tensión DC
- Tensión AC
- Corriente DC
- Corriente AC
- Capacidad, Frecuencia, y...  
(dependiendo del modelo)



- ❖ Es un instrumento de gran utilidad para chequear el circuito cuando no funciona

# Multímetro digital

- Instrumento que permite medir:
  - Resistencia
  - Tensión DC
  - Tensión AC
  - Corriente DC
  - Corriente AC
  - Capacidad,
  - Frecuencia
  - Temperatura
  - Continuidad, diodo, transistor (dependiendo del modelo)

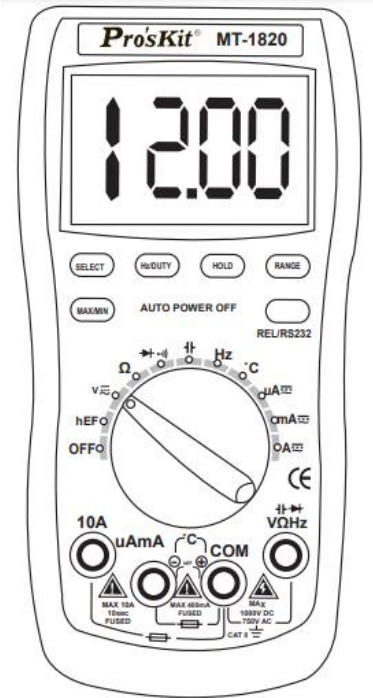

Pantalla digital de 3 5/6 dígitos  
lectura posible hasta 5999

Selector de función  
Rango automático

Bornes de entrada

Modelo	MT-1820
Display	3 5/6 digit (5999) LCD
DC voltaje, V	600mV/6V/60V/600V $\pm(0.5\%+4d)$ 1000V $\pm(1.0\%+6d)$
AC voltaje, V	6V/60V/600V $\pm(0.8\%+10d)$ 750V $\pm(1.0\%+10d)$
DC corriente, A	600 $\mu$ A/6000 $\mu$ A $\pm(1.0\%+10d)$ 60mA/600mA $\pm(1.0\%+10d)$ 6A/10A $\pm(1.2\%+10d)$
AC corriente, A	600 $\mu$ A/6000 $\mu$ A $\pm(1.5\%+10d)$ 60mA/600mA $\pm(1.5\%+10d)$ 6A/10A $\pm(2.0\%+15d)$
Resistencia, $\Omega$	600 $\Omega$ $\pm(0.8\%+5d)$ 6k $\Omega$ /60k $\Omega$ /600k $\Omega$ /6M $\Omega$ $\pm(0.8\%+4d)$ 60M $\Omega$ $\pm(1.2\%+10d)$
Funciones especiales	chequeo de transistores
Frecuencia, Hz	100Hz/1000Hz/10kHz/ /100kHz/1MHz/20MHz $\pm(0.5\%+4d)$
Capacitancia, F	40nF $\pm(5.0\%+30d)$ 400nF/4 $\mu$ F/40 $\mu$ F $\pm(3.5\%+8d)$ 200 $\mu$ F $\pm(5.0\%+10d)$
Temperatura, $^{\circ}$ C	-20~400 $^{\circ}$ C $\pm(1.0\%+5d)$ 400~1000 $^{\circ}$ C $\pm(1.5\%+15d)$

# PRECAUCIONES

Para no quemar el fusible interno o romper el multímetro:

- ❑ **Desconectar el multímetro del circuito cuando se conmute la función de medida**
- ❑ Chequear que la corriente no supera el máximo admitido por la entrada
- ❑ Chequear que la tensión de entrada no supera el máximo admitido por la entrada
- ❑ Si no tiene rango automático empezar a medir con las escalas de mayor rango y pasar a escalas inferiores

