

Programmer Manual



AFG3000 Series Arbitrary/Function Generators 071-1639-04

This document supports firmware version 3.0.0 and above.

www.tektronix.com

Copyright © Tektronix. All rights reserved. Licensed software products are owned by Tektronix or its subsidiaries or suppliers, and are protected by national copyright laws and international treaty provisions.

Tektronix products are covered by U.S. and foreign patents, issued and pending. Information in this publication supercedes that in all previously published material. Specifications and price change privileges reserved.

TEKTRONIX and TEK are registered trademarks of Tektronix, Inc.

Contacting Tektronix

Tektronix, Inc.
14200 SW Karl Braun Drive or P.O. Box 500
Beaverton, OR 97077 USA

For product information, sales, service, and technical support:

- In North America, call 1-800-833-9200
- Worldwide, visit www.tektronix.com to find contacts in your area.

WARRANTY 16

Tektronix warrants that the product will be free from defects in materials and workmanship for a period of three (3) years from the date of original purchase from an authorized Tektronix distributor. If the product proves defective during this warranty period, Tektronix, at its option, either will repair the defective product without charge for parts and labor, or will provide a replacement in exchange for the defective product. Batteries are excluded from this warranty. Parts, modules and replacement products used by Tektronix for warranty work may be new or reconditioned to like new performance. All replaced parts, modules and products become the property of Tektronix.

In order to obtain service under this warranty, Customer must notify Tektronix of the defect before the expiration of the warranty period and make suitable arrangements for the performance of service. Customer shall be responsible for packaging and shipping the defective product to the service center designated by Tektronix, shipping charges prepaid, and with a copy of customer proof of purchase. Tektronix shall pay for the return of the product to Customer if the shipment is to a location within the country in which the Tektronix service center is located. Customer shall be responsible for paying all shipping charges, duties, taxes, and any other charges for products returned to any other locations.

This warranty shall not apply to any defect, failure or damage caused by improper use or improper or inadequate maintenance and care. Tektronix shall not be obligated to furnish service under this warranty a) to repair damage resulting from attempts by personnel other than Tektronix representatives to install, repair or service the product; b) to repair damage resulting from improper use or connection to incompatible equipment; c) to repair any damage or malfunction caused by the use of non-Tektronix supplies; or d) to service a product that has been modified or integrated with other products when the effect of such modification or integration increases the time or difficulty of servicing the product.

THIS WARRANTY IS GIVEN BY TEKTRONIX WITH RESPECT TO THE PRODUCT IN LIEU OF ANY OTHER WARRANTIES, EXPRESS OR IMPLIED. TEKTRONIX AND ITS VENDORS DISCLAIM ANY IMPLIED WARRANTIES OF MERCHANTABILITY OR FITNESS FOR A PARTICULAR PURPOSE. TEKTRONIX' RESPONSIBILITY TO REPAIR OR REPLACE DEFECTIVE PRODUCTS IS THE SOLE AND EXCLUSIVE REMEDY PROVIDED TO THE CUSTOMER FOR BREACH OF THIS WARRANTY. TEKTRONIX AND ITS VENDORS WILL NOT BE LIABLE FOR ANY INDIRECT, SPECIAL, INCIDENTAL, OR CONSEQUENTIAL DAMAGES IRRESPECTIVE OF WHETHER TEKTRONIX OR THE VENDOR HAS ADVANCE NOTICE OF THE POSSIBILITY OF SUCH DAMAGES.

Table of Contents

Preface	ix
Documentation	x

Getting Started

Getting Started	1-1
Front Panel Controls	1-2
Display Area and Screen Interface	1-11
Waveform Parameters and Numeric Input	1-14
Rear Panel	1-19

Syntax and Commands

Syntax and Commands	2-1
Command Syntax	2-1
Command Groups	2-9
Command Descriptions	2-15
ABORt (No Query Form)	2-15
AFGControl:CSCopy (No Query Form)	2-16
*CAL?	2-16
CALibration[:ALL]	2-17
*CLS (No Query Form)	2-17
DIAGnostic[:ALL]	2-18
DISPlay:CONTrast	2-19
DISPlay:SAVER:IMMediate (No Query Form)	2-19
DISPlay:SAVER[:STATe]	2-20
DISPlay[:WINDow]:TEXT[:DATA]	2-21
DISPlay[:WINDow]:TEXT:CLear (No Query Form)	2-21
*ESE	2-22
*ESR?	2-23
HCOPy:SDUMp[:IMMediate] (No query form)	2-23
*IDN?	2-24
MEMory:STATe:VALid?	2-24
MEMory:STATe:DELete (No Query Form)	2-25
MEMory:STATe:LOCK	2-25
MEMory:STATe:RECall:AUTo	2-26
MMEMory:CATalog?	2-27
MMEMory:CDIRectory	2-28
MMEMory:DELete (No Query Form)	2-28
MMEMory:LOAD:STATe (No Query Form)	2-29
MMEMory:LOAD:TRACe (No Query Form)	2-29
MMEMory:LOCK[:STATe]	2-30
MMEMory:MDIRectory (No Query Form)	2-30
MMEMory:STORe:STATe (No Query Form)	2-31
MMEMory:STORe:TRACe (No Query Form)	2-31
*OPC	2-32
*OPT?	2-32

OUTPut[1 2]:IMPedance	2-33
OUTPut[1 2]:POLarity	2-34
OUTPut[1 2][:STATe]	2-34
OUTPut:TRIGger:MODE	2-35
*PSC	2-36
*RCL (No Query Form)	2-36
*RST (No Query Form)	2-37
*SAV (No Query Form)	2-37
[SOURce[1 2]]:AM[:DEPTh]	2-38
[SOURce[1 2]]:AM:INTErnal:FREQuency	2-39
[SOURce[1 2]]:AM:INTErnal:FUNcTION	2-40
[SOURce[1 2]]:AM:INTErnal:FUNcTION:EFILe	2-41
[SOURce[1 2]]:AM:SOURce	2-41
[SOURce[1 2]]:AM:STATe	2-42
[SOURce[1 2]]:BURSt:MODE	2-42
[SOURce[1 2]]:BURSt:NCYCles	2-43
[SOURce[1 2]]:BURSt[:STATe]	2-44
[SOURce[1 2]]:BURSt:TDELaY	2-45
[SOURce[1 2]]:COMBine:FEED	2-46
[SOURce[1 2]]:FM[:DEVIation]	2-47
[SOURce[1 2]]:FM:INTErnal:FREQuency	2-48
[SOURce[1 2]]:FM:INTErnal:FUNcTION	2-49
[SOURce[1 2]]:FM:INTErnal:FUNcTION:EFILe	2-50
[SOURce[1 2]]:FM:SOURce	2-50
[SOURce[1 2]]:FM:STATe	2-51
[SOURce[1 2]]:FREQuency:CENTer	2-52
[SOURce[1 2]]:FREQuency:CONCurrenT[:STATe]	2-53
[SOURce[1 2]]:FREQuency[:CW]:FIXed]	2-54
[SOURce[1 2]]:FREQuency:MODE	2-55
[SOURce[1 2]]:FREQuency:SPAN	2-56
[SOURce[1 2]]:FREQuency:STARt	2-57
[SOURce[1 2]]:FREQuency:STOP	2-58
[SOURce[1 2]]:FSKey[:FREQuency]	2-59
[SOURce[1 2]]:FSKey:INTErnal:RATE	2-59
[SOURce[1 2]]:FSKey:SOURce	2-60
[SOURce[1 2]]:FSKey:STATe	2-60
[SOURce[1 2]]:FUNcTION:EFILe	2-61
[SOURce[1 2]]:FUNcTION:RAMP:SYMMetry	2-61
[SOURce[1 2]]:FUNcTION[:SHAPE]	2-62
[SOURce[1 2]]:PHASe[:ADJust]	2-63
[SOURce[1 2]]:PHASe:INITiate (No Query Form)	2-64
[SOURce[1 2]]:PM[:DEVIation]	2-64
[SOURce[1 2]]:PM:INTErnal:FREQuency	2-65
[SOURce[1 2]]:PM:INTErnal:FUNcTION	2-66
[SOURce[1 2]]:PM:INTErnal:FUNcTION:EFILe	2-67
[SOURce[1 2]]:PM:SOURce	2-67
[SOURce[1 2]]:PM:STATe	2-68
SOURce<3 4>:POWer[:LEVel][:IMMediate][:AMPLitude]	2-69
[SOURce[1 2]]:PULSe:DCYCLE	2-70
[SOURce[1 2]]:PULSe:DELaY	2-70
[SOURce[1 2]]:PULSe:HOLD	2-71

[SOURCE[1 2]]:PULSE:PERIOD	2-72
[SOURCE[1 2]]:PULSE:TRANSITION[:LEADING]	2-72
[SOURCE[1 2]]:PULSE:TRANSITION:TRAILING	2-73
[SOURCE[1 2]]:PULSE:WIDTH	2-74
[SOURCE[1 2]]:PWM:INTERNAL:FREQUENCY	2-75
[SOURCE[1 2]]:PWM:INTERNAL:FUNCTION	2-76
[SOURCE[1 2]]:PWM:INTERNAL:FUNCTION:EFILE	2-77
[SOURCE[1 2]]:PWM:SOURCE	2-77
[SOURCE[1 2]]:PWM:STATE	2-78
[SOURCE[1 2]]:PWM[:DEVIATION]:DCYCLE	2-79
[SOURCE]:ROSCILLATOR:SOURCE	2-80
[SOURCE[1 2]]:SWEET:HTIME	2-80
[SOURCE[1 2]]:SWEET:MODE	2-81
[SOURCE[1 2]]:SWEET:RTIME	2-82
[SOURCE[1 2]]:SWEET:SPACING	2-82
[SOURCE[1 2]]:SWEET:TIME	2-83
[SOURCE[1 2]]:VOLTAGE:CONCURRENT[:STATE]	2-84
[SOURCE[1 2]]:VOLTAGE[:LEVEL][:IMMEDIATE]:HIGH	2-85
[SOURCE[1 2]]:VOLTAGE[:LEVEL][:IMMEDIATE]:LOW	2-86
[SOURCE[1 2]]:VOLTAGE[:LEVEL][:IMMEDIATE]:OFFSET	2-87
[SOURCE[1 2]]:VOLTAGE[:LEVEL][:IMMEDIATE][:AMPLITUDE]	2-88
[SOURCE[1 2]]:VOLTAGE:LIMIT:HIGH	2-89
[SOURCE[1 2]]:VOLTAGE:LIMIT:LOW	2-90
[SOURCE[1 2]]:VOLTAGE:UNIT	2-91
*SRE	2-92
STATUS:OPERATION:CONDITION?	2-93
STATUS:OPERATION:ENABLE	2-93
STATUS:OPERATION[:EVENT]?	2-94
STATUS:PRESET (No Query Form)	2-94
STATUS:QUESTIONABLE:CONDITION?	2-95
STATUS:QUESTIONABLE:ENABLE	2-95
STATUS:QUESTIONABLE[:EVENT]?	2-96
*STB?	2-96
SYSTEM:BEEP[:IMMEDIATE] (No Query Form)	2-97
SYSTEM:BEEP:STATE	2-97
SYSTEM:ERROR[:NEXT]?	2-98
SYSTEM:KCLICK[:STATE]	2-98
SYSTEM:KLOCK[:STATE]	2-99
SYSTEM:PASSWORD:CDISABLE (No Query Form)	2-99
SYSTEM:PASSWORD[:CENABLE] (No Query Form)	2-100
SYSTEM:PASSWORD[:CENABLE]:STATE?	2-100
SYSTEM:PASSWORD:NEW (No Query Form)	2-101
SYSTEM:SECURITY:IMMEDIATE (No Query Form)	2-101
SYSTEM:ULANGUAGE	2-102
SYSTEM:VERSION?	2-102
TRACE DATA:CATALOG?	2-103
TRACE DATA:COPY (No Query Form)	2-103
TRACE DATA[:DATA]	2-104
TRACE DATA[:DATA]:LINE (No Query Form)	2-105
TRACE DATA[:DATA]:VALUE	2-106
TRACE DATA:DEFINE (No Query Form)	2-107

TRACe DATA:DELeTe[:NAME] (No Query Form)	2-108
TRACe DATA:LOCK[:STATe].	2-108
TRACe DATA:POINts	2-109
*TRG (No Query Form)	2-109
TRIGger[:SEQuence]:SLOPe	2-110
TRIGger[:SEQuence]:SOURce	2-110
TRIGger[:SEQuence]:TIMer	2-111
TRIGger[:SEQuence][:IMMediate] (No Query Form).	2-111
*TST?	2-112
*WAI (No Query Form)	2-112

Status and Events

Status and Events	3-1
Status Reporting Structure.	3-1
Registers	3-4
Queues	3-10
Messages and Codes	3-11

Programming Examples

Programming Examples	4-1
---------------------------------------	------------

Appendices

Appendix A: Accessories and Options	A-1
Options	A-1
Accessories	A-2
Appendix B: General Care and Cleaning	B-1
General Care	B-1
Cleaning	B-1
Appendix C: SCPI Conformance Information	C-1
Appendix D: Default Setup	D-1
Appendix E: Reference	E-1
Menu System.	E-1
Menu Structure	E-2
File Operations	E-30

Index

Index	Index-1
------------------------	----------------

List of Figures

Figure 1-1: Dual-channel model	1-1
Figure 1-2: Front panel controls	1-2
Figure 1-3: Waveform parameter and graph display	1-4
Figure 1-4: Graph comparison	1-4
Figure 1-5: Waveform parameter comparison (CH1 selected)	1-5
Figure 1-6: Waveform parameter comparison (CH2 selected)	1-5
Figure 1-7: Run Mode menu (Continuous)	1-8
Figure 1-8: Screen interface	1-11
Figure 1-9: Level meter	1-12
Figure 1-10: Graphical representation of button status	1-13
Figure 1-11: Default display	1-14
Figure 1-12: Frequency/Period/Phase Menu	1-14
Figure 1-13: Screen display with Frequency active (1)	1-15
Figure 1-14: Screen display with Frequency active (2)	1-15
Figure 1-15: Screen display with Frequency active (3)	1-15
Figure 1-16: Screen display with Frequency active (4)	1-16
Figure 1-17: Amplitude/Level Menu	1-16
Figure 1-18: PWM sample screen	1-17
Figure 1-19: PWM parameter menu (Freq is selected)	1-17
Figure 1-20: PWM parameter menu (Period is selected)	1-18
Figure 1-21: Rear panel connectors	1-19
Figure 2-1: Command message elements	2-3
Figure 2-2: Example of SCPI subsystem hierarchy tree	2-4
Figure 2-3: Example of abbreviating a command	2-6
Figure 2-4: Example of chaining commands and queries	2-7
Figure 2-5: Example of omitting root and lower level nodes	2-7
Figure 3-1: Error and event handling process	3-2
Figure 3-2: The Status Byte Register (SBR)	3-5
Figure 3-3: The Standard Event Status Register (SESR)	3-6
Figure 3-4: Operation Condition Register (OCR)	3-7
Figure 3-5: Questionable Condition Register (QCR)	3-8
Figure 3-6: Event Status Enable Register (ESER)	3-9
Figure 3-7: Service Request Enable Register (SRER)	3-9
Figure 3-8: Operation Enable Register (OENR)	3-9
Figure 3-9: Questionable Enable Register (QENR)	3-10
Figure A-1: Fuse adapter	A-3
Figure E-1: Sweep type	E-9
Figure E-2: Frequency sweep	E-10
Figure E-3: Number of Points	E-16
Figure E-4: Using the Cursor (Line edit)	E-18
Figure E-5: Line Edit example	E-19
Figure E-6: Operation – Edit by Data Point	E-19

Figure E-7: Cut example	E-20
Figure E-8: Paste at Beginning	E-21
Figure E-9: Paste at End	E-22
Figure E-10: Browse waveform files (USB memory)	E-30
Figure E-11: Write As - Character entry box	E-32
Figure E-12: Recall menu (Internal)	E-33
Figure E-13: Save As - Character entry box	E-34

List of Tables

Table 2-1: BNF notation	2-1
Table 2-2: Command message elements	2-2
Table 2-3: Query response examples	2-3
Table 2-4: Parameter types used in syntax descriptions	2-5
Table 2-5: Calibration and Diagnostic commands	2-9
Table 2-6: Display commands	2-9
Table 2-7: Memory commands	2-9
Table 2-8: Mass Memory commands	2-10
Table 2-9: Output commands	2-10
Table 2-10: Source commands	2-10
Table 2-11: Status commands	2-12
Table 2-12: System commands	2-13
Table 2-13: Synchronization commands	2-13
Table 2-14: Trace commands	2-14
Table 2-15: Trigger commands	2-14
Table 2-16: AFG Control command	2-14
Table 2-17: Screen copy command	2-14
Table 3-1: SBR bit functions	3-5
Table 3-2: SESR bit functions	3-6
Table 3-3: OCR bit functions	3-7
Table 3-4: QCR bit functions	3-8
Table 3-5: Definition of event codes	3-11
Table 3-6: Command error messages	3-11
Table 3-7: Execution error messages	3-13
Table 3-8: Device-specific error messages	3-15
Table 3-9: Query errors	3-15
Table 3-10: Power-on events	3-15
Table 3-11: User request events	3-16
Table 3-12: Request control events	3-16
Table 3-13: Operation complete events	3-16
Table 3-14: Device errors	3-17
Table A-1: Options	A-1
Table A-2: Standard accessories	A-2
Table A-3: Optional accessories	A-2
Table C-1: SCPI conformance information	C-1
Table D-1: Default settings	D-1
Table E-1: Sine/Square menu	E-3
Table E-2: Ramp menu	E-4
Table E-3: Pulse menu	E-4
Table E-4: Arb menu	E-5
Table E-5: More menu	E-6

Table E-6: Modulation parameter menu	E-7
Table E-7: Sweep parameter menu	E-9
Table E-8: Burst parameter menu	E-11
Table E-9: Output menu	E-12
Table E-10: Save/Recall menu	E-13
Table E-11: Edit menu	E-14
Table E-12: Operations submenu	E-17
Table E-13: Utility menu	E-23

Preface

This manual provides operating information for the AFG3000 Series Arbitrary/Function Generators. The following instruments are supported by this manual:

AFG3011	AFG3021B	AFG3022B
AFG3101	AFG3102	AFG3251
AFG3252		

The manual consists of the following sections:

- *Getting Started* covers operating principles of the instrument, which helps you understand how your generator operates.
- *Syntax and Commands* defines the command syntax and processing conventions, describes command notation.
- *Status and Events* explains the status information and event messages reported by the instrument.
- *Programming Examples* contains remote interface application programs to help you develop programs for your application.
- *Appendix A: Accessories & Options* describes the standard and optional accessories as well as the instrument options.
- *Appendix B: General Care and Cleaning* describes how to take care of the instrument.
- *Appendix C: SCPI Conformance Information* contains a list of commands and SCPI information.
- *Appendix D: Default Setup* contains a list of the menus and controls that are recalled when you push the front-panel **Default** button.
- *Appendix E: Reference* provides in-depth descriptions of the instrument menu structures and menu button functions.

Documentation

In addition to this *AFG3000 Series Arbitrary/Function Generators Programmer Manual*, the following documentation is available for this instrument:

AFG3000 Series Quick Start User Manual. The quick start user manual provides information on installation, general features, operating the instrument, and user interface. It also provides electrical, environmental, and physical specifications for the instrument.

Built in Help System. The built-in help system that is integrated with the User Interface application that ships with this instrument.

AFG3000 Series Service Manual. A service manual is available as an optional accessory. The service manual includes procedures to service the instrument to the module level. The manual also includes performance verification procedures so that you can verify performance to the advertised specifications.



Getting Started

Getting Started

The AFG3000 Series Arbitrary/Function Generators front panel is divided into easy to use functional areas. This section provides you with a quick overview of the controls. Figure 1-1 shows the front panel of dual-channel model.

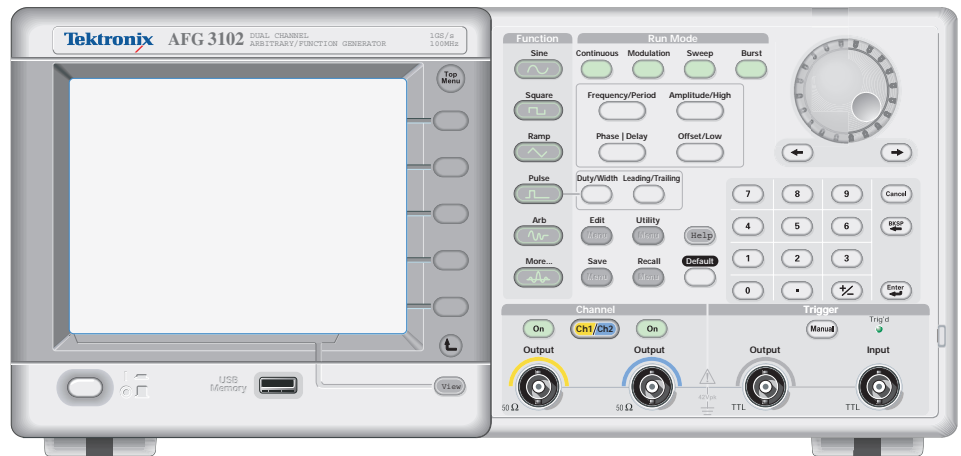

Figure 1-1: Dual-channel model

Front Panel Controls

This section introduces you to the front panel controls of the instrument and provides a brief overview on how to use the front panel key controls.

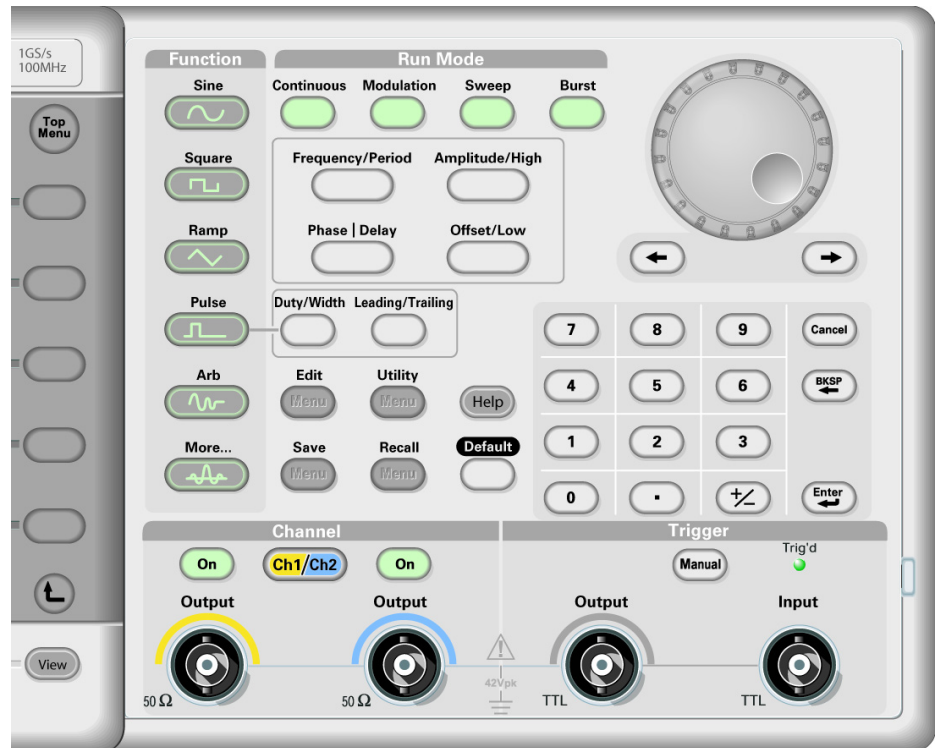

Figure 1-2: Front panel controls

The AFG3000 Series Arbitrary/Function Generators front-panel key controls are divided into the following categories:

- Action buttons
- Menu buttons
- State buttons
- Function buttons
- Shortcut buttons

Action Buttons

The Power (not shown in Figure 1-2), Upper Menu, Top Menu, View, and Manual Trigger buttons are called action buttons. When you push these action buttons, it will cause an action.

Power button. Pushing the power button once turns the instrument on. Pushing the power button when the instrument is on will turn off the instrument.

Upper Menu button. Pushing the **Upper Menu**  button returns the currently displayed bezel menu to the upper level of the menu tree.

Top Menu button. The **Top Menu**  button is used to return to the top level of the menu tree from the current menu location.

View button. The **View**  button is used to toggle the screen view format. The arbitrary/function generator provides the following three screen view formats:

- View format 1: Waveform parameter and graph display, see Figure 1-3
- View format 2: Graph comparison, see Figure 1-4
- View format 3: Waveform parameter comparison, see Figure 1-5 and Figure 1-6

When the instrument is in one of the three display format, pushing the **View** button will toggle through the three views in a repeating cycle in the order described above.

When the instrument is in the Edit Menu, pushing the **View** button will toggle between Edit text and graphical views. This is the only function of the single-channel model view button.

When the instrument is in the Save/Recall, Utility, Output, or Help menu, pushing the **View** button will have no effect.

View Format 1. Figure 1-3 is a single channel parameter and graph setup display. In this view, Channel 1 is selected with the Channel Select button. When Channel 2 is selected, the parameters and graph for Channel 2 will be displayed in this view. You can easily toggle between the information for Channel 1 and Channel 2 with this view.

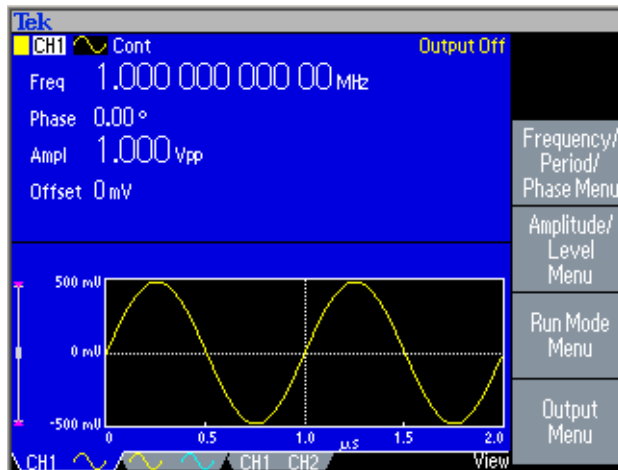

Figure 1-3: Waveform parameter and graph display

View Format 2. Figure 1-4 is a graph compare view. In this view, the Channel Select button selects the active graph. The selected channel is highlighted.

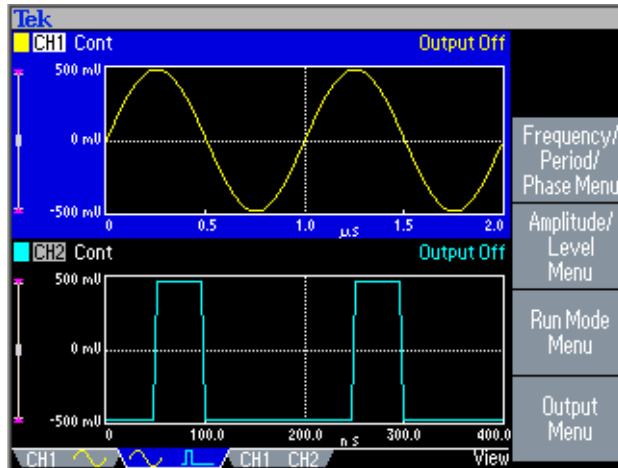

Figure 1-4: Graph comparison

View Format 3. Figure 1-5 is a channel compare view. In this view, Channel 1 is selected with the Channel Select button.

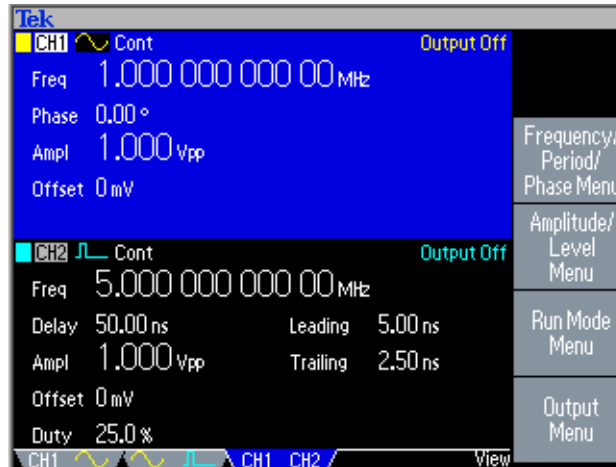

Figure 1-5: Waveform parameter comparison (CH1 selected)

In Figure 1-6, Channel 2 is selected with the Channel Select button.



Figure 1-6: Waveform parameter comparison (CH2 selected)

Manual Trigger button. Pushing the **Manual Trigger** button generates a trigger event manually. The Manual Trigger is one of the trigger sources for sweep or burst waveform. If you push the Manual Trigger button, the arbitrary/function generator will initiate one sweep in the Trigger Sweep mode, or output a waveform that has the specified number of cycles in the Burst mode. If the instrument is in Gated mode, it outputs a waveform while the Manual Trigger button is depressed.

Trig'd LED. The Trig'd LED is lit whenever the instrument responds to a trigger. Note that the Trig'd LED is a common display for any trigger signals for channel 1 or channel 2.

Other Action buttons. The Enter button and the following related buttons are also classified as Action buttons.

- **Enter button.** The **Enter** button causes a numeric input to be updated.
- **+/- button.** This button is only active when you are setting a value. The +/- button changes the sign of the currently selected parameter from positive to negative. If the value is already negative, this button makes it positive.
- **Cancel button.** The **Cancel** button is active when you are setting a value. Pushing the **Cancel** button closes the Units menu and restores the previous value for the selected setting.

When the front-panel controls are locked, you can use the **Cancel** button to unlock the front-panel controls. See page 1-10.

- **Backspace (BKSP) button.** The **BKSP** button is only active when you are setting a value in the Numeric Input Area. Pushing the **BKSP** button deletes the currently selected digit.

Menu Buttons The Edit, Utility, Save, Recall, Help, and Default buttons are called Menu buttons.

Edit button. The **Edit** button opens Edit menu. See Table E-11 on page E-14 for the Edit menu map.

Utility button. The **Utility** button opens Utility menu. See Table E-13 on page E-23 for the Utility menu map.

Save button. The **Save** button opens the Save menu. See Table E-10 on page E-13 for the Save menu map.

Recall button. The **Recall** button opens the Recall menu. See Table E-10 on page E-13 for the Recall menu map.

Help button. The **Help** button opens the built-in Help.

Default button. The **Default** button restores the instrument settings to the default values. When you push this button, you will be prompted on the display with a pop-up window message requesting you to confirm that you want to restore the defaults. See *Default Setup* on page D-1 for the settings when you push the **Default** button.

Run Mode buttons. When one of four Run Mode buttons is selected, the menu for configuring the run mode is displayed on the screen. See *State buttons* on page 1-7.

State Buttons

The Channel Select, CH1/CH2 Output and Run Mode buttons are called State buttons.

Channel Select button. The Channel Select  button directly controls the display, toggling between the two channels. This button is used to select the channel that you are currently interacting with. Only one channel can be selected at a time.

When you push the Channel Select button on the Edit, Utility, Save, Recall, or Help screen, the arbitrary/function generator returns to previous display. The displayed channels do not toggle if you push the Channel Select button on those screen menus. After restoring the main display area, pushing the Channel Select button toggles between CH1 and CH2.

CH1/CH2 Output On button. The arbitrary/function generator allow you to turn on and off the signal output for CH1 and CH2 independently. You can configure the signal with the outputs off, to minimize the chance of sending a problematic signal to your device. You can select either one or both of these buttons. Each button is lit with an LED when in the On state.

Run Mode buttons. Only one Run Mode menu can be selected for each channel. The Run Mode buttons are unique because they are both State and Menu buttons. When one of four buttons is selected, that run mode is activated and the menu for configuring that run mode is displayed on the screen. The selected button is lit with an LED.

- Continuous
- Modulation
- Sweep
- Burst

If your instrument is a dual-channel model, Run Mode can be set independently for each channel.

Select the **Run Mode Menu** bezel button from the default screen (see page 1-14) to display the Run Mode menus. The Continuous mode is selected in Figure 1-7. If you select Modulation, Sweep, or Burst as the Run Mode, the corresponding bezel menu is highlighted.

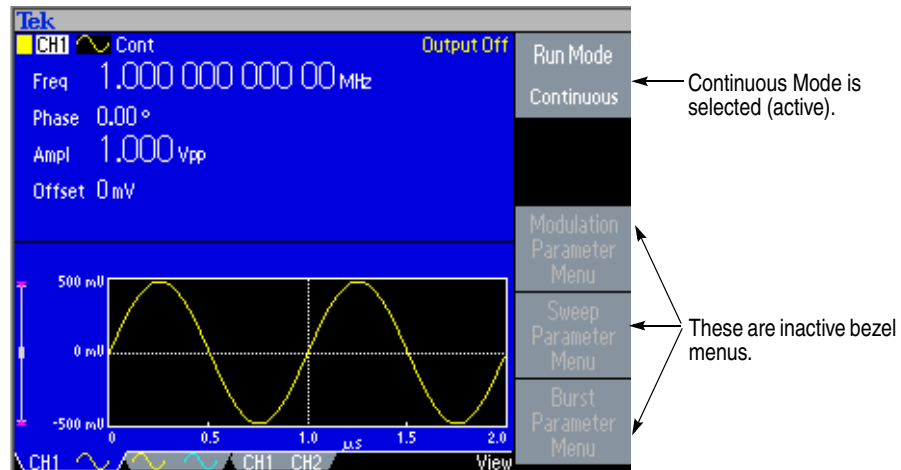

Figure 1-7: Run Mode menu (Continuous)

Function Buttons

Only one of the Function buttons can be selected for each channel at a time. The selected button will be lit with an LED.

Sine button. Pushing the **Sine** button selects the sine waveform, causing the Sine button LED to turn on. See Table E-1 on page E-3 for the menu map.

Square button. Pushing the **Square** button selects the square waveform, causing the Square button LED to turn on. See Table E-1 on page E-3 for the menu map.

Ramp button. Pushing the **Ramp** button selects the ramp waveform, causing the Ramp button LED to turn on. See Table E-2 on page E-4 for the menu map.

Pulse button. Pushing the **Pulse** button selects the pulse waveform, causing the Pulse button LED to turn on. See Table E-3 on page E-4 for the menu map.

Arb button. Pushing the **Arb** button causes the Arb waveform menu to be displayed on the screen, and causes the Arb LED to turn on. See Table E-4 on page E-5 for the menu map.

More... button. Pushing the **More...** button causes the More waveform menu to be displayed on the screen, and causes the More... LED to turn on. See Table E-5 on page E-6 for the menu map.

Shortcut Buttons

The following six buttons are called Shortcut buttons and are provided as shortcuts for experienced users. You can push this button while viewing any of the display types. If you are not in view format 1, 2, or 3 (see page 1-3), pushing the shortcut button will take you to the last view you used and highlight the selected setting.

Frequency/Period button. This button selects the setting that was last used (**Frequency** or **Period**). If Frequency was selected, you can change the shortcut by selecting Period with the bezel menu. The next time you push the Frequency/Period button, Period will be selected. This shortcut button allows you to select the setting and enter their numeric value using the front panel, without requiring any bezel menu selection.

Amplitude/High button. This button selects the setting that was last used (**Amplitude** or **High Level**).

Offset/Low button. This button selects the setting which was last used (**Offset** or **Low Level**).

Duty/Width button. This button only operates when the **Pulse** function is selected for the current channel. Otherwise, the button does nothing when pushed. The instrument remembers which setting (**Duty** or **Width**) was last selected from the bezel menu and highlights that setting when this shortcut button is pushed.

Leading/Trailing button. This button only operates when the **Pulse** function is selected for the current channel, otherwise, the button does nothing when pushed. The instrument remembers which setting (**Leading Edge** or **Trailing Edge**) was last selected from the bezel menu and highlights that setting when this shortcut button is pushed.

Phase | Delay button. This shortcut button is different from the other buttons. This button does not toggle between two parameters. For example, if you push the **Phase | Delay** shortcut button in the pulse parameter menu, **Delay** becomes active. Pushing the **Phase | Delay** button again will have no effect, because there is no Phase parameter in the pulse parameter menu. Similarly, when you push the **Phase | Delay** button in the Sine, Square, or Ramp parameter menu, **Phase** becomes active. Pushing the button again will have no effect, because there is no Delay parameter in these menus.

Knob and Arrow Keys

The general purpose knob can be used to increase and decrease selected numeric values. The arrow keys (digit select keys) are used to move the underbar to a field that contains an editable number. This will allow you to change the digit with the knob. Refer to page 1-15 for entering or changing numeric values using the knob and the arrow keys.

BNC Connectors

Refer to Figure 1-2 on page 1-2 for the locations of the front panel BNC connectors.

CH1 Output. This BNC connector will output the Channel 1 signal. This connector will be deactivated when the Channel 1 output button is not selected. The load impedance for this connection can be set in the Output Menu.

CH2 Output. Same functionality as Channel 1 Output. This output is not present in the single channel instrument model.

Trigger Output. This connector provides a TTL level pulse synchronized with the Channel 1 output. The connector provides a signal that will allow an oscilloscope to synchronize with the arbitrary/function generator.

When you synchronize multiple arbitrary/function generators, the Trigger Output on the master instrument is connected to the Trigger Input of the slave instrument.

Trigger Input. When the arbitrary/function generator is a slave to another device, The Trigger Input connector will be used to synchronize the arbitrary/function generator with the master device. Trigger signals from other devices can also be input here.

USB Memory

The USB Memory connector is a host connector, which allows a USB client memory device to be connected. You can perform the following tasks:

- Save or recall user-defined waveforms to/from a USB memory
- Save or recall setups to/from files on a USB memory
- Update your arbitrary/function generator firmware
- Save a screen image



CAUTION. Do not remove USB memory while writing or reading data. It may cause data loss and the USB memory may be damaged.

When you attach a USB memory to the instrument, a caution message appears on the screen. Do not remove the USB memory until the message disappears.

If you remove the USB memory while this caution message is displayed, it may cause damage to the instrument.

To Unlock Front Panel Controls

The front panel may be locked by a remote user while the instrument is being remotely controlled via GPIB, USB or Ethernet. When the front panel is locked, all keys and buttons are disabled except the power switch. The “Lock” symbol at the top right of the screen indicates that the instrument front-panel controls are locked.

To unlock the front-panel, use the remote command or push the front-panel **Cancel** button twice in a row. This method is not applied if the arbitrary/function generator is in the GPIB LLO (Local Lockout) state.

Display Area and Screen Interface

Figure 1-8 shows the main areas of the instrument display.

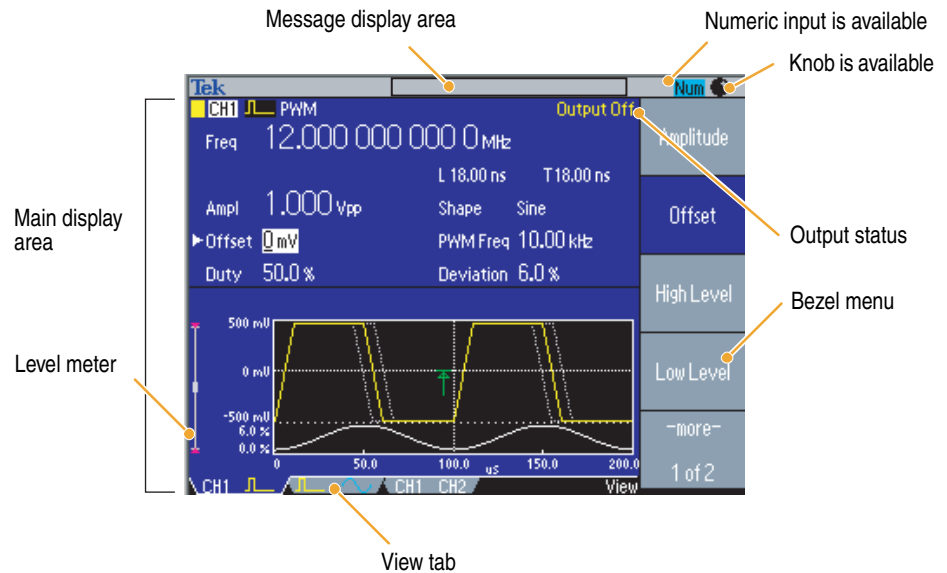

Figure 1-8: Screen interface

Main Display Area

Pushing the front-panel **View** button changes the view format of the main display area. See page 1-3 for screen view formats.

View Tab. The view tabs correspond with the current view format.

Output Status. If the output is set to disable, the **Output Off** message is displayed in this area. When you push the front-panel channel output button to enable the output, the message will disappear.

From the Output menu, you can set the load impedance, invert a waveform, or add an external signal to the CH1 output. The status will change based on the output status.

Screen Copy

You can save a screen image of the arbitrary/function generator to a USB memory. Push the front-panel two arrow keys underneath the rotary knob simultaneously after setting the display to show the screen you want to save as image.

Level Meter. Amplitude level is displayed. To protect your DUT (device under test), use the Output Menu to set the limit values for high level and low level. Figure 1-9 shows Level Meter.

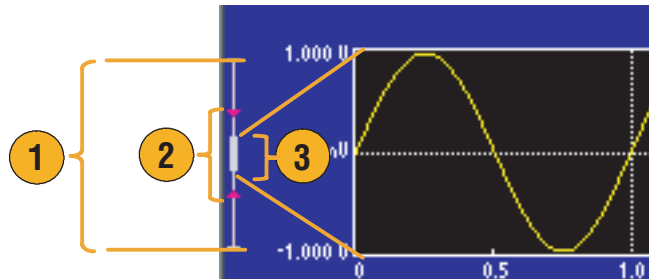

Figure 1-9: Level meter

1. Shows maximum amplitude level of your instrument.
2. Shows the range of high limit and low limit that you have set.
3. Shows the amplitude level that is currently selected.

Message Display Area

A message that monitors hardware status such as clock or trigger is displayed in this area.

The arbitrary/function generator displays a message at the top of the screen, which conveys the following types of information about hardware status:

- External Reference out of range
- Waiting for Trigger

You can also display a text message in this area by using the following remote command. See page 2-21.

```
DISPlay[:WINDow]:TEXT[:DATA]
```

Bezel Menu Display Area

When you push a front panel button, the instrument displays the corresponding menu on the right side of the screen. The menu shows the options that are available when you push the unlabeled bezel buttons directly to the right of the screen. (Some documentation may also refer to the bezel buttons as side-menu buttons or soft keys.)

The AFG3000 Series Arbitrary/Function Generators use four types of menu button status. See Figure 1-10.

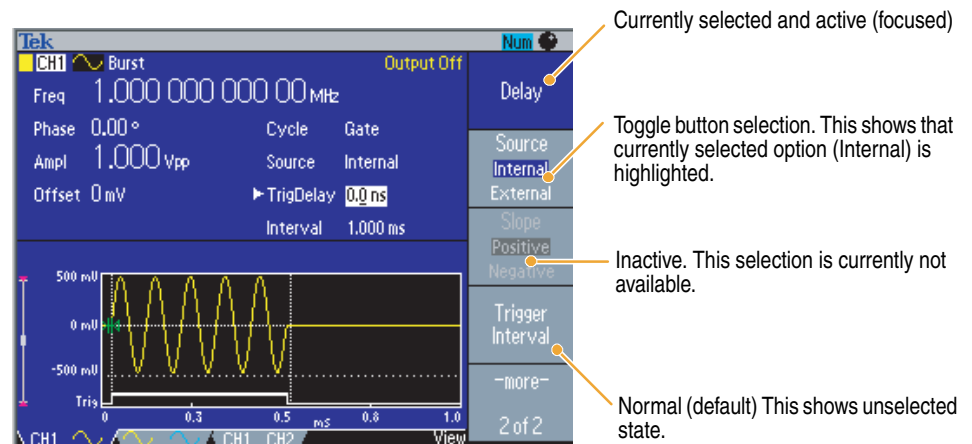

Figure 1-10: Graphical representation of button status

- **Focused (active)** – Blue background and white type
The bezel menu item is currently selected.
- **Non-Focused** – Medium gray background and white type, blue box around type only
There are some toggle button selections within the bezel menus. For example, Internal and External. You can specify either one but not both of these parameters.
- **Inactive** – Medium gray background and light gray type
This selection is currently not available because of the other instrument settings.
- **Normal (default)** – Medium gray background and white type
This is the currently unselected state.

Waveform Parameters and Numeric Input

This section explains how to set or change the waveform parameters of the arbitrary/function generator using the front-panel controls or bezel menu selection.

Changing Parameters Using the Bezel Menu

The arbitrary/function generator outputs a sine waveform of 1 MHz frequency with 1 V_{p-p} by default. You can use the following two methods to set or change the waveform parameters:

- Using the bezel menu selection
- Using the front-panel shortcut buttons (see page 1-17)

Figure 1-11 shows the default display of sine waveform.

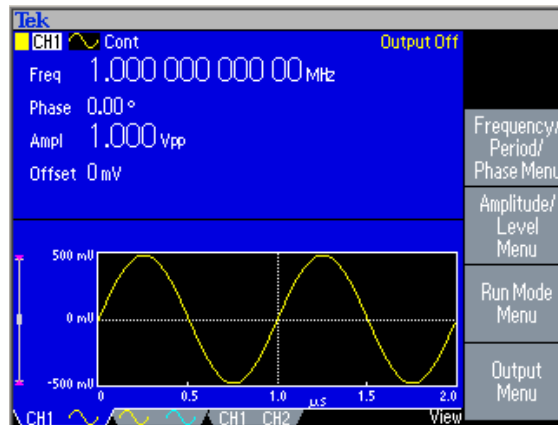

Figure 1-11: Default display

Select the **Frequency/Period/Phase Menu** bezel button from the default display, you can change the values of frequency, period, or phase.

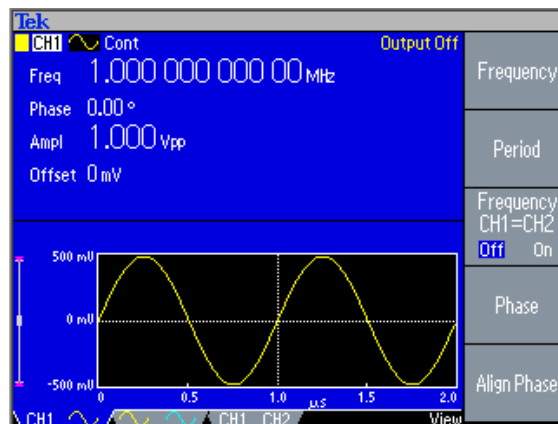

Figure 1-12: Frequency/Period/Phase Menu

Numeric Input

If you want to change the frequency value, push the **Frequency** bezel button. The value of Freq in main display area changes to “selected status”. The Freq is displayed in black type inside a white box. See Figure 1-13.

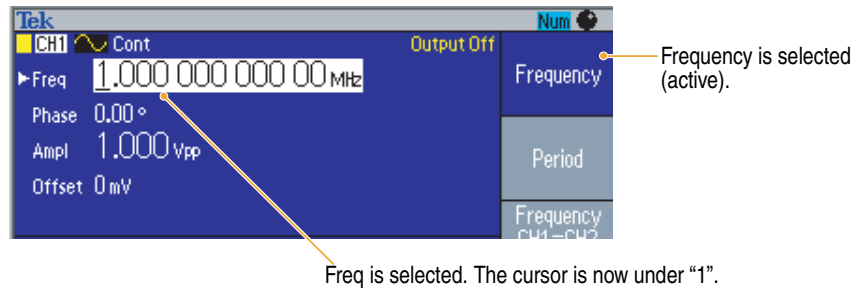

Figure 1-13: Screen display with Frequency active (1)

To move the cursor, use the arrow keys.

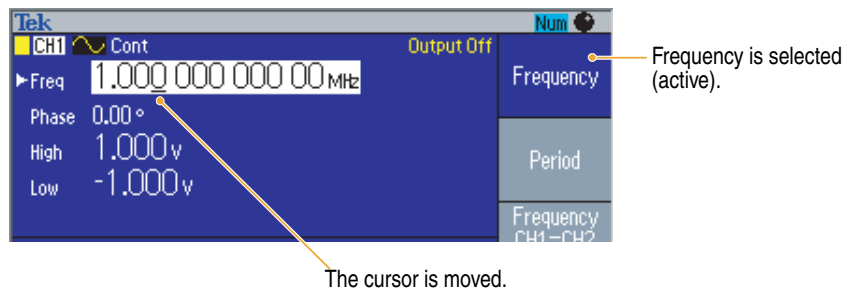

Figure 1-14: Screen display with Frequency active (2)

To change the value, use the general purpose knob. Turn the knob clockwise to increase the value; turn the knob counterclockwise to decrease the value.

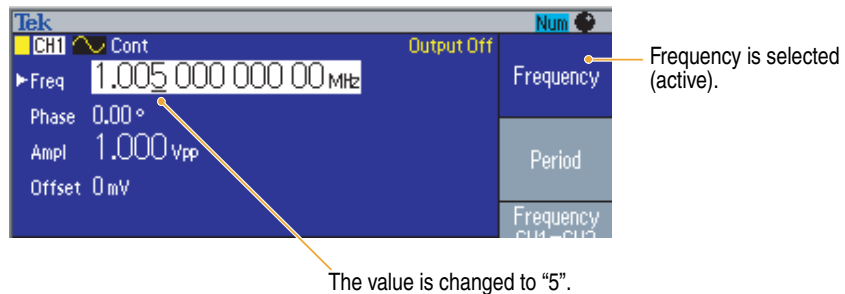

Figure 1-15: Screen display with Frequency active (3)

You can also change the value with the front-panel numeric key-pad. Entering any value from the numeric key-pad will automatically change the bezel menu to Units. See Figure 1-16.

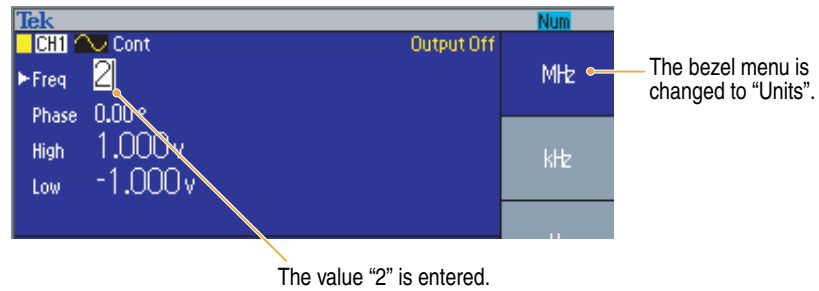



Figure 1-16: Screen display with Frequency active (4)

After entering the frequency value, push the Units bezel button or the front-panel **Enter** button to complete the entry.

To change the amplitude value, push the Top Menu  button, and then select the **Amplitude/Level Menu** bezel button. You can change the values of amplitude, offset, high level, or low level.

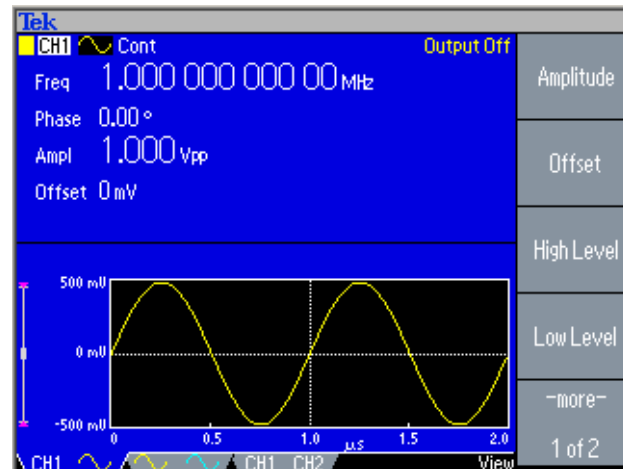

Figure 1-17: Amplitude/Level Menu

Changing Parameters Using the Shortcut Buttons

The shortcut buttons are provided for experienced users. The buttons allow you to select a setup parameter without using any bezel menu selection. The following example shows how the Frequency/Period shortcut button works.

You can use the shortcut buttons while viewing any of the display formats. Push a shortcut button to display the last view type and highlight the selected parameter setting. Figure 1-18 is a sample screen of Pulse Width Modulation parameter menu display.

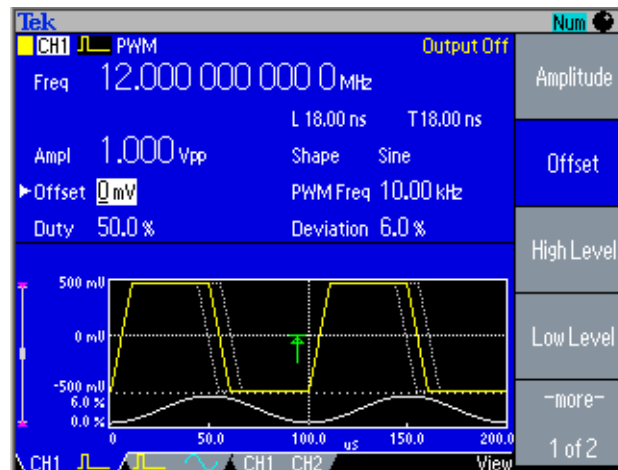

Figure 1-18: PWM sample screen

From Figure 1-18, pushing the **Frequency/Period** shortcut button will change the bezel menu to look like Figure 1-19.

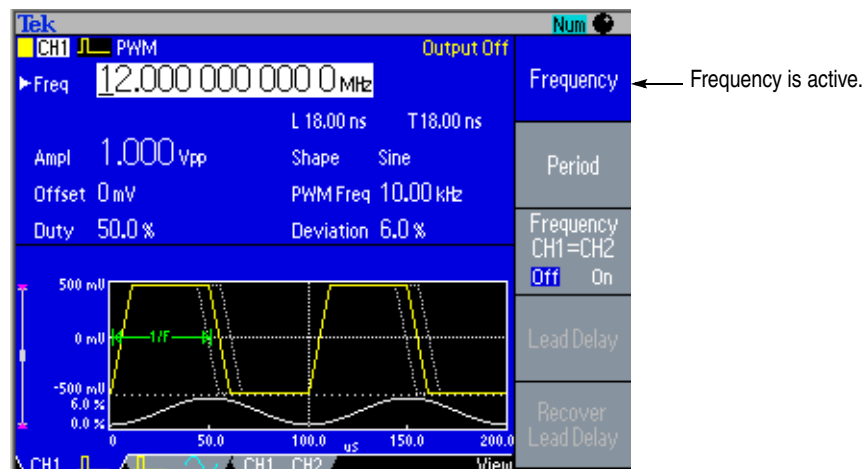

Figure 1-19: PWM parameter menu (Freq is selected)

You can now change the frequency value. If you push the **Frequency/Period** shortcut button again, the active parameter will change to Period. See Figure 1-20.

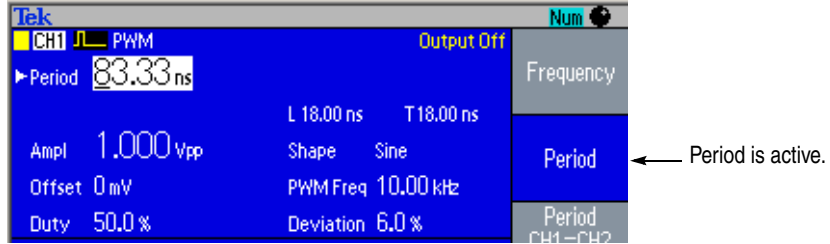

Figure 1-20: PWM parameter menu (Period is selected)

The **Frequency/Period** shortcut button is used to select the setting that was last used (**Frequency** or **Period**). If Frequency was selected, you can change the shortcut by pushing the shortcut button again. The next time you push the **Frequency/Period** button, **Period** will be selected.

NOTE. The **Duty/Width** and **Leading/Trailing** shortcut buttons are operational only when **Pulse** is selected in the **Functional** button.

Rear Panel

Figure 1-21 shows the locations of the instrument rear panel connectors.

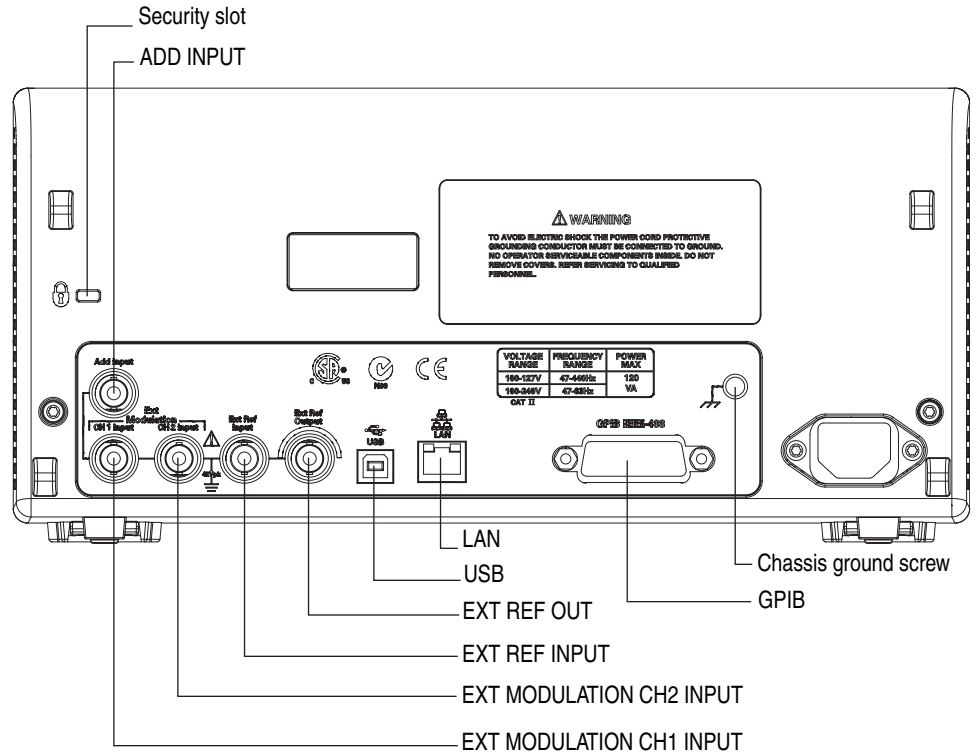

Figure 1-21: Rear panel connectors

EXT REF INPUT. This input is used when synchronizing multiple arbitrary/function generators or an arbitrary/function generator and another device.

EXT REF OUTPUT. This output is used when synchronizing multiple arbitrary/function generators or an arbitrary/function generator and another device.

ADD INPUT. (AFG310x and AFG325x) Additional Input connector allows you to input a signal from some other source and add that signal to CH 1 output.

EXT MODULATION CH 1 INPUT. A signal applied to the External Modulation CH 1 Input connector is used to modulate the CH 1 output signal. The signal input level applied to this connector will control the modulation depth.

EXT MODULATION CH 2 INPUT. (Dual-channel model only) The External Modulation CH 2 Input connector is used to apply an external modulating signal to the CH 2 output signal. The signal input level applied to this connector will control the modulation depth.

USB. The USB connector is used to connect a USB controller.

LAN. This connector is used to connect the arbitrary/function generator to a network. Connect a 10BASE-T or 100BASE-T cable here.

GPIB. The GPIB connector is used to control the arbitrary/function generator through remote commands.

Security Slot. Use a standard laptop computer security cable to secure your arbitrary/function generator to your location.

Chassis Ground Screw. The chassis ground screw is used to ground the arbitrary/function generator. Use a unified coarse screw (#6-32, 6.35 mm length or less).



Syntax and Commands

Syntax and Commands

This section provides the following information:

- *Command Syntax* defines the command syntax and processing conventions.
- *Command Groups* describes command groups which lists the commands by function.
- *Command Descriptions* describes the notation of each of the commands in alphabetical order.

Command Syntax

You can control the operations and functions of the arbitrary/function generator through the GPIB interface using commands and queries. The related topics listed below describe the syntax of these commands and queries. The topics also describe the conventions that the instrument uses to process them. See the *Command Groups* on page 2-9 for a listing of the commands by command group, or use the index to locate a specific command.

Backus-Naur Form Notation. This manual describes the commands and queries using Backus-Naur Form (BNF) notation. Refer to Table 2-1 for the symbols that are used.

Table 2-1: BNF notation

Symbol	Meaning
< >	Defined element
::=	Is defined as
	Exclusive OR
{ }	Group; one element is required
[]	Optional; can be omitted
...	Previous element(s) may be repeated
()	Comment

Command and Query Structure

Commands consist of set commands and query commands (usually simply called commands and queries). Commands change instrument settings or perform a specific action. Queries cause the instrument to return data and information about its status.

Most commands have both a set form and a query form. The query form of the command is the same as the set form except that it ends with a question mark. For example, the set command `DISPlay:CONTRast` has a query form `DISPlay:CONTRast?`. Not all commands have both a set and a query form; some commands are set only and some are query only.

A few commands do both a set and query action. For example, the `*CAL?` command runs a self-calibration program on the instrument, then returns the result of the calibration.

A command message is a command or query name, followed by any information the instrument needs to execute the command or query. Command messages consist of five element types.

Table 2-2 lists and describes the five different element types.

Table 2-2: Command message elements

Symbol	Meaning
<Header>	The basic command name. If the header ends with a question mark, the command is a query. The header may begin with a colon (:) character; if the command is concatenated with other commands the beginning colon is required. The beginning colon can never be used with command headers beginning with a star (*).
<Mnemonic>	A header subfunction. Some command headers have only one mnemonic. If a command header has multiple mnemonics, they are always separated from each other by a colon (:) character.
<Argument>	A quantity, quality, restriction, or limit associated with the header. Not all commands have an argument, while other commands have multiple arguments. Arguments are separated from the header by a <Space>. Arguments are separated from each other by a <Comma>.
<Comma>	A single comma between arguments of multiple-argument commands. It may optionally have white space characters before and after the comma.
<Space>	A white space character between command header and argument. It may optionally consist of multiple white space characters.

Figure 2-1 shows the five command message elements.

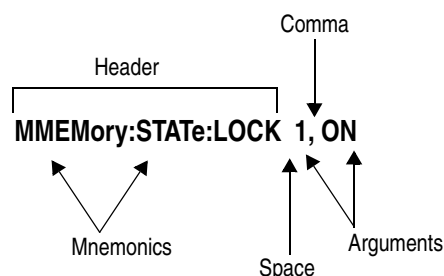

Figure 2-1: Command message elements

Commands. Commands cause the instrument to perform a specific function or change one of its settings. Commands have the structure:

```
[:]<Header>[<Space><Argument>[<Comma><Argument>]...]
```

A command header is made up of one or more mnemonics arranged in a hierarchical or tree structure. The first mnemonic is the base or root of the tree and each subsequent mnemonic is a level or branch of the previous one. Commands at a higher level in the tree may affect those at a lower level. The leading colon (:) always returns you to the base of the command tree.

Queries. Queries cause the arbitrary/function generator to return information about its status or settings. Queries have the structure:

```
[:]<Header>?
```

```
[:]<Header>?[<Space><Argument>[<Comma><Argument>]...]
```

You can specify a query command at any level within the command tree unless otherwise noted. These branch queries return information about all the mnemonics below the specified branch or level.

Query Responses. When a query is sent to the arbitrary/function generator, only the values are returned. When the returned value is a mnemonic, it is noted in abbreviated format, as shown in Table 2-3.

Table 2-3: Query response examples

Query	Response
SOURce:PULSe:DCYcle?	50.0
OUTPut:POLarity?	NORM

Command Entry Follow these general rules when entering commands:

- Enter commands in upper or lower case.
- You can precede any command with white space characters. White space characters include any combination of the ASCII control characters 00 through 09 and 0B through 20 hexadecimal (0 through 9 and 11 through 32 decimal).
- The instrument ignores commands that consists of just a combination of white space characters and line feeds.

SCPI Commands and Queries

The arbitrary/function generator uses a command language based on the SCPI standard. The SCPI (Standard Commands for Programmable Instruments) standard was created by a consortium to provide guidelines for remote programming of instruments. These guidelines provide a consistent programming environment for instrument control and data transfer. This environment uses defined programming messages, instrument responses and data formats that operate across all SCPI instruments, regardless of manufacturer.

The SCPI language is based on a hierarchical or tree structure that represents a subsystem (see Figure 2-2). The top level of the tree is the root node; it is followed by one or more lower-level nodes.

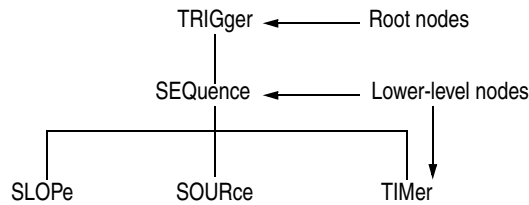

Figure 2-2: Example of SCPI subsystem hierarchy tree

You can create commands and queries from these subsystem hierarchy trees. Commands specify actions for the instrument to perform. Queries return measurement data and information about parameter settings.

Creating Commands

SCPI commands are created by stringing together the nodes of a subsystem hierarchy and separating each node by a colon.

In Figure 2-2, TRIGger is the root node and SEquence, SLOPe, SOURce, and TIMer are lower level nodes. To create an SCPI command, start with the root node TRIGger and move down the tree structure adding nodes until you reach the end of a branch. Most commands and some queries have parameters; you must include a value for these parameters. The command descriptions, which begin on page 2-15, list the valid values for all parameters.

For example, TRIGger:SEquence:SOURce EXTernal is a valid SCPI command created from the hierarchy tree in Figure 2-2.

Parameter Types

Parameters are indicated by angle brackets, such as <file_name>. There are several different types of parameters, as listed in Table 2-4. The parameter type is listed after the parameter. Some parameter types are defined specifically for the arbitrary/function generator command set and some are defined by SCPI.

Table 2-4: Parameter types used in syntax descriptions

Parameter type	Description	Example
arbitrary block	A block of data bytes	#512234xxxxx... where 5 indicates that the following 5 digits (12234) specify the length of the data in bytes; xxxxx... indicates the data or #0xxxxx...<LF><&EOI>
boolean	Boolean numbers or values	ON or ≠ 0 OFF or 0
discrete	A list of specific values	MIN, MAX
binary	Binary numbers	#B0110
octal	Octal numbers	#Q75, #Q3
hexadecimal	Hexadecimal numbers (0-9, A-F)	#HAA, #H1
NR1 numeric	Integers	0, 1, 15, -1
NR2 numeric	Decimal numbers	1.2, 3.141516, -6.5
NR3 numeric	Floating point numbers	3.1415E-9, -16.1E5
NRf numeric	Flexible decimal number that may be type NR1, NR2, or NR3	See NR1, NR2, NR3 examples in this table
string	Alphanumeric characters (must be within quotation marks)	"Testing 1, 2, 3"

Special Characters

The Line Feed (LF) character or the New Line (NL) character (ASCII 10), and all characters in the range of ASCII 127-255 are defined as special characters. These characters are used in arbitrary block arguments only; using these characters in other parts of any command yields unpredictable results.

Abbreviating Commands, Queries, and Parameters

You can abbreviate most SCPI commands, queries, and parameters to an accepted short form. This manual shows these commands as a combination of upper and lower case letters. The upper case letters indicate the accepted short form of a command, as shown in Figure 2-3. The accepted short form and the long form are equivalent and request the same action of the instrument.

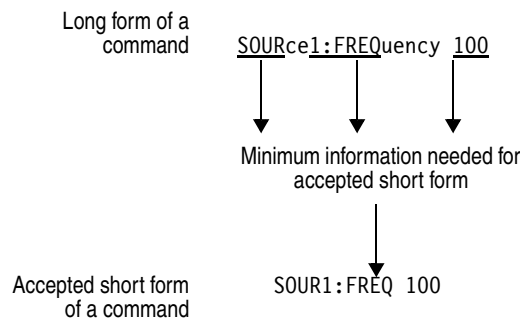

Figure 2-3: Example of abbreviating a command

NOTE. The numeric suffix of a command or query may be included in either the long form or short form. The arbitrary/function generator will default to “1” if no suffix is used.

Chaining Commands and Queries

You can chain several commands or queries together into a single message. To create a chained message, first create a command or query, then add a semicolon (;), and finally add more commands or queries and semicolons until you are done. If the command following a semicolon is a root node, precede it with a colon (:). Figure 2-4 illustrates a chained message consisting of several commands and queries. The chained message should end in a command or query, not a semicolon. Responses to any queries in your message are separated by semicolons.

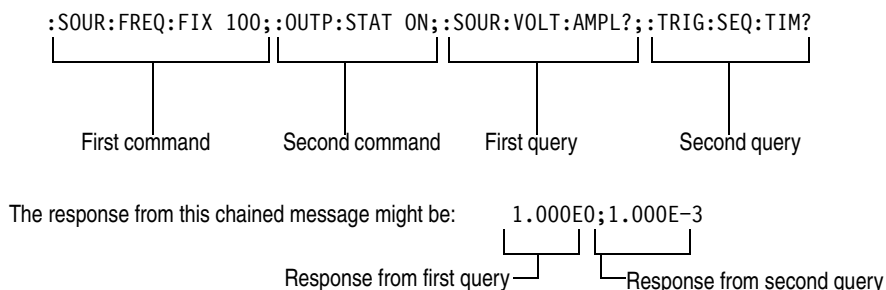

Figure 2-4: Example of chaining commands and queries

If a command or query has the same root and lower-level nodes as the previous command or query, you can omit these nodes. In Figure 2-5, the second command has the same root node (SEquence) as the first command, so these nodes can be omitted.

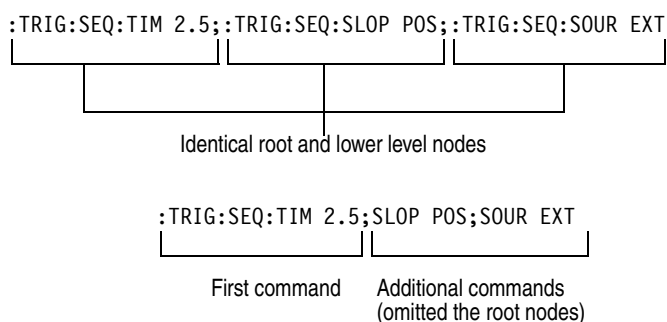

Figure 2-5: Example of omitting root and lower level nodes

Units and SI Prefix

If the decimal numeric argument refers to voltage, frequency, impedance, or time, you can express it using SI units instead of using the scaled explicit point input value format `<NR3>`. (SI units are units that conform to the System International d'Unites standard.) For example, you can use the input format `200 mV` or `1.0 MHz` instead of `200.0E-3` or `1.0E+6`, respectively, to specify voltage or frequency.

General Rules for Using SCPI commands

The following are three general rules for using SCPI commands, queries, and parameters:

- You can use single (' ') or double (" ") quotation marks for quoted strings, but you cannot use both types of quotation marks for the same string.

correct "This string uses quotation marks correctly."

correct 'This string also uses quotation marks correctly.'

incorrect "This string does not use quotation marks correctly.'

- You can use upper case, lower case, or a mixture of both cases for all commands, queries, and parameters.

 :SOURCE:FREQUENCY 10MHZ

is the same as

 :source:frequency 100mhz

and

 :SOURCE:frequency 10MHZ

NOTE. *Quoted strings are case sensitive.*

- No embedded spaces are allowed between or within nodes.

correct :OUTPUT:FILTER:LPASS:FREQUENCY 200MHZ

incorrect :OUTPUT: FILTER: LPASS:FREQUENCY 200MHZ

Command Groups

This section lists the commands organized by functional group. The Command Descriptions section, starting on page 2-15, lists all commands alphabetically.

Calibration and Diagnostic Commands. Calibration and Diagnostic commands let you initiate the instrument self-calibration routines and examine the results of diagnostic tests. Table 2-5 lists Calibration and Diagnostic commands.

Table 2-5: Calibration and Diagnostic commands

Header	Description
*CAL?	Perform self-calibration and return result status
CALibration[:ALL]	Perform self-calibration
DIAGnostic[:ALL]	Perform self-test
*TST?	Perform self-test and return result status

Display Commands. Display commands let you change the graticule style, displayed contrast, and other display attributes. Table 2-6 lists and describes Display commands.

Table 2-6: Display commands

Header	Description
DISPlay:CONTrast	Set/query the LCD display contrast
DISPlay:SAVer:IMMEDIATE	Set screen saver.
DISPlay:SAVer[:STATE]	Set/query the screen saver settings
DISPlay[:WINDow]:TEXT[:DATA]	Set/query the text message display
DISPlay[:WINDow]:TEXT:CLEAr	Delete text message

Memory Commands. Memory commands let you change setup memory attributes. Table 2-7 lists and describes Memory commands.

Table 2-7: Memory commands

Header	Description
MEMory:STATe:VALid?	Query the availability of setup memory
MEMory:STATe:DELeTe	Delete the setup memory
MEMory:STATe:LOCK	Set/query the lock of setup memory overwrite and deletion
MEMory:STATe:RECall:AUTO	Set/query the recall of last set memory
*RCL	Recall instrument setting from setup memory
*SAV	Save instrument setting to setup memory

Mass Memory Commands. Mass Memory commands let you change mass memory attributes. Table 2-8 lists and describes Mass Memory commands.

Table 2-8: Mass Memory commands

Header	Description
MMEMory:CATalog?	Query the status of mass memory
MMEMory:CDIRectory	Set/query current directory
MMEMory:DElete	Delete file or directory in mass memory
MMEMory:LOAD:STATe	Copy instrument setting in mass memory to setup memory
MMEMory:LOAD:TRACe	Copy waveform data file in mass memory to edit memory
MMEMory:LOCK[:STATe]	Set/query the lock of mass memory overwrite and deletion
MMEMory:MDIRectory	Create directory in mass memory
MMEMory:STORe:STATe	Save the setup memory status to mass memory
MMEMory:STORe:TRACe	Save waveform data file in edit memory to mass memory

Output Commands. Output commands let you set output attributes. Table 2-9 lists and describes Output commands.

Table 2-9: Output commands

Header	Description
OUTPut[1 2]:IMPedance	Set/query impedance
OUTPut[1 2]:POLarity	Set/query polarity
OUTPut[1 2][:STATe]	Set/query output on or off
OUTPut:TRIGger:MODE	Set/query the mode of Trigger Output

Source Commands. Source commands let you set waveform output parameters. Table 2-10 lists and describes Source commands.

Table 2-10: Source commands

Header	Description
[SOURce]:ROSCillator:SOURce	Set/query clock reference input
[SOURce[1 2]]:AM:STATe	Set/query amplitude modulation status
[SOURce[1 2]]:AM:INTernal:FREQuency	Set/query internal modulation frequency
[SOURce[1 2]]:AM:INTernal:FUNcTion	Set/query modulation waveform setting
[SOURce[1 2]]:AM:INTernal:FUNcTion:EFILe	Set/query EFILe setting
[SOURce[1 2]]:AM:SOURce	Set/query amplitude modulation source
[SOURce[1 2]]:AM[:DEPTH]	Set/query amplitude modulation depth
[SOURce[1 2]]:BURSt:MODE	Set/query burst mode
[SOURce[1 2]]:BURSt:NCYCles	Set/query burst mode waveform output cycle
[SOURce[1 2]]:BURSt:TDELay	Set/query burst mode trigger delay time

Table 2-10: Source commands (cont.)

Header	Description
[SOURce[1 2]]:BURSt [:STATe]	Set/query burst mode status
[SOURce[1 2]]:COMBine:FEED	Set/query internal noise or external signal
[SOURce[1 2]]:FM:INTernal:FREQuency	Set/query internal modulation frequency
[SOURce[1 2]]:FM:INTernal:FUNcTion	Set/query internal modulation waveform
[SOURce[1 2]]:FM:INTernal:FUNcTion:EFILe	Set/query EFILe setting
[SOURce[1 2]]:FM:SOURce	Set/query frequency modulation source
[SOURce[1 2]]:FM:STATe	Set/query frequency modulation status
[SOURce[1 2]]:FM [:DEViation]	Set/query frequency deviation
[SOURce[1 2]]:FREQuency:CENTer	Set/query center frequency
[SOURce[1 2]]:FREQuency:CONCurent[:STATe]	Set/query concurrent change of frequency
[SOURce[1 2]]:FREQuency:MODE	Set/query sweep status
[SOURce[1 2]]:FREQuency:SPAN	Set/query sweep frequency span
[SOURce[1 2]]:FREQuency:STARt	Set/query sweep start frequency
[SOURce[1 2]]:FREQuency:STOP	Set/query sweep stop frequency
[SOURce[1 2]]:FREQuency [:CW]:FIXed]	Set/query output waveform frequency
[SOURce[1 2]]:FSKey:INTernal:RATE	Set/query FSK internal modulation rate
[SOURce[1 2]]:FSKey:SOURce	Set/query FSK source
[SOURce[1 2]]:FSKey:STATe	Set/query FSK status
[SOURce[1 2]]:FSKey [:FREQuency]	Set/query FSK hop frequency
[SOURce[1 2]]:FUNcTion:RAMP:SYMMetry	Set/query ramp waveform symmetry
[SOURce[1 2]]:FUNcTion [:SHAPe]	Set/query output waveform
[SOURce[1 2]]:FUNcTion:EFILe	Set/query EFILe name
[SOURce[1 2]]:PHASe:INITiate	Initiate output waveform phase synchronization
[SOURce[1 2]]:PHASe[:ADJust]	Set/query output waveform phase
[SOURce[1 2]]:PM:INTernal:FREQuency	Set/query internal modulation frequency
[SOURce[1 2]]:PM:INTernal:FUNcTion	Set/query internal modulation waveform
[SOURce[1 2]]:PM:INTernal:FUNcTion:EFILe	Set/query EFILe name
[SOURce[1 2]]:PM:SOURce	Set/query phase modulation source
[SOURce[1 2]]:PM:STATe	Set/query phase modulation status
[SOURce[1 2]]:PM [:DEViation]	Set/query phase modulation deviation
SOURce<3 4>:POWer [:LEVel][:IMMEDIATE] [:AMPLitude]	Set/query internal noise level
[SOURce[1 2]]:PULSe:DCYCLE	Set/query pulse waveform duty cycle
[SOURce[1 2]]:PULSe:DELay	Set/query pulse waveform lead delay
[SOURce[1 2]]:PULSe:HOLD	Set/query pulse waveform parameter
[SOURce[1 2]]:PULSe:PERiod	Set/query pulse waveform period
[SOURce[1 2]]:PULSe:TRANSition[:LEADing]	Set/query pulse waveform leading edge time
[SOURce[1 2]]:PULSe:TRANSition:TRAILing	Set/query pulse waveform trailing edge time
[SOURce[1 2]]:PULSe:WIDTh	Set/query pulse waveform width

Table 2-10: Source commands (cont.)

Header	Description
[SOURce[1 2]]:PWM:INTernal:FREQuency	Set/query pulse width modulation frequency
[SOURce[1 2]]:PWM:INTernal:FUNCTion	Set/query pulse width modulation waveform
[SOURce[1 2]]:PWM:INTernal:FUNCTion:EFILe	Set/query EFILE name
[SOURce[1 2]]:PWM:SOURce	Set/query pulse width modulation source
[SOURce[1 2]]:PWM:STATe	Set/query pulse width modulation status
[SOURce[1 2]]:PWM[:DEVIation]:DCYClE	Set/query pulse width modulation deviation
[SOURce[1 2]]:SWEep:HTIME	Set/query sweep hold time
[SOURce[1 2]]:SWEep:MODE	Set/query sweep mode
[SOURce[1 2]]:SWEep:RTIME	Set/query sweep return time
[SOURce[1 2]]:SWEep:SPACing	Set/query sweep spacing
[SOURce[1 2]]:SWEep:TIME	Set/query sweep time
[SOURce[1 2]]:VOLTage:CONCurent[:STATe]	Set/query concurrent change of amplitude level
[SOURce[1 2]]:VOLTage:LIMit:HIGH	Set/query output amplitude upper limit
[SOURce[1 2]]:VOLTage:LIMit:LOW	Set/query output amplitude lower limit
[SOURce[1 2]]:VOLTage:UNIT	Set/query output amplitude units
[SOURce[1 2]]:VOLTage[:LEVel][:IMMediate]:HIGH	Set/query output amplitude high level
[SOURce[1 2]]:VOLTage[:LEVel][:IMMediate]:LOW	Set/query output amplitude low level
[SOURce[1 2]]:VOLTage[:LEVel][:IMMediate]:OFFSet	Set/query output offset voltage
[SOURce[1 2]]:VOLTage[:LEVel][:IMMediate][:AMPLitude]	Set/query output amplitude

Status Commands. Status commands let you determine the status of the instrument. Table 2-11 lists and describes Status commands.

Table 2-11: Status commands

Header	Description
*CLS	Clear all event registers and queues
*ESE	Set/query standard event status enable register
*ESR?	Return standard event status register
*PSC	Set/query power-on status clear
*SRE	Set/query service request enable register
*STB?	Read status byte
STATus:OPERation[:EVENT]?	Return operation event register
STATus:OPERation:CONDition?	Return operation condition register
STATus:OPERation:ENABLE	Set/query operation enable register
STATus:PRESet	Preset SCPI enable register

Table 2-11: Status commands (cont.)

Header	Description
STATus:QUESTionable[:EVENT]?	Return questionable event register
STATus:QUESTionable:CONDition?	Return questionable condition register
STATus:QUESTionable:ENABLE	Set/query questionable enable register

System Commands. System commands let you control miscellaneous instrument functions. Table 2-12 lists and describes System commands.

Table 2-12: System commands

Header	Description
*IDN?	Return identification information
*OPT?	Return option information
*RST	Reset
SYSTem:BEEPer:STATe	Set/query beeper state
SYSTem:BEEPer[:IMMEDIATE]	Generate an audible tone
SYSTem:ERRor[:NEXT]?	Return error event queue
SYSTem:KCLick[:STATe]	Set/query click sound
SYSTem:KLOCK[:STATe]	Set/query front panel lock/unlock
SYSTem:PASSword:CDISable	Disable protected commands
SYSTem:PASSword[:CENable]	Enable protected commands to function
SYSTem:PASSword[:CENable]:STATe?	Return security protection state
SYSTem:PASSword:NEW	Change current password
SYSTem:SECurity:IMMEDIATE	Reset to factory default
SYSTem:ULANguage	Set/query language for display screen
SYSTem:VERSion?	Return version information

Synchronization Commands. Synchronization commands let you synchronize the operation of the instrument. Table 2-13 lists and describes Synchronization commands.

Table 2-13: Synchronization commands

Header	Description
*OPC	Set/query operation complete
*WAI	Wait to continue

Trace Commands. Trace commands let you set the edit memory and user waveform memory. Table 2-14 lists and describes Trace commands.

Table 2-14: Trace commands

Header	Description
TRACe DATA:CATalog?	Return user waveform memory status
TRACe DATA:COpy	Copy edit memory (or user waveform memory) content to user waveform memory (or edit memory)
TRACe DATA[:DATA]	Set/query waveform data to edit memory
TRACe DATA:DELeTe[:NAME]	Delete user waveform memory contents
TRACe DATA:DEFine	Set edit memory content
TRACe DATA:LOCK[:STATe]	Set/query lock/unlock of user waveform memory
TRACe DATA:POINts	Set/query number of points for waveform data in edit memory
TRACe DATA[:DATA]:LINE	Write waveform data with interpolation
TRACe DATA[:DATA]:VALue	Set/query waveform data in edit memory

Trigger Commands. Trigger commands let you control all aspects of arbitrary/function generator triggering. Table 2-15 lists and describes Trigger commands.

Table 2-15: Trigger commands

Header	Description
ABORt	Initialize trigger system
*TRG	Force trigger event
TRIGger[:SEQuence]:SLOPe	Set/query the slope of trigger signal
TRIGger[:SEQuence]:SOURce	Set/query the source of trigger signal
TRIGger[:SEQuence]:TIMer	Set/query the period of internal clock
TRIGger[:SEQuence] [:IMMediate]	Generate a trigger event

AFG Control. AFG Control command copies setups between two channels.

Table 2-16: AFG Control command

Header	Description
AFGControl:CSCopy	Copy CH1 (or CH2) setup parameters to CH2 (or CH1)

Screen Copy. Screen copy command copies screen image.

Table 2-17: Screen copy command

Header	Description
HCOPy:SDUMp[:IMMediate]	Copy screen image and save the file to USB memory.

Command Descriptions

Commands either set or query instrument values. Some commands both set and query, some only set, and some only query.

Manual Conventions

This manual uses the following conventions:

- No Query Form indicates set-only commands
- A question mark (?) appended to the commands and Query Only indicates query-only commands
- Fully spells out headers, mnemonics, and arguments with the minimal spelling shown in upper case; for example, to use the abbreviated form of the DISPLAY:CONTRast command, just type DISP:CONT
- Syntax of some commands varies, depending on the model of arbitrary/function generator you are using; differences are noted

ABORt (No Query Form)

Initializes all the current trigger system parameters and resets all trigger sequences.

Group	Trigger
Syntax	ABORt
Arguments	None
Examples	ABORt resets the trigger system.

AFGControl:CSCopy (No Query Form)

This command copies setup parameters for one channel to another channel.

If your arbitrary/function generator is a single-channel model, this command is not supported.

Group	AFG Control
Syntax	AFGControl:CSCopy {CH1 CH2},{CH1 CH2}
Arguments	CH1 CH2
Examples	AFGControl:CSCopy CH1,CH2 copies the CH1 setup parameters into CH2.

*CAL?

This command performs an internal calibration and returns 0 (Pass) or a calibration error code.

NOTE. *The self-calibration can take several minutes to complete. During this time, the arbitrary/function generator does not execute any commands. Do not power off the instrument during the self-calibration.*

Group	Calibration and Diagnostic
Related Commands	CALibration[:ALL]?
Syntax	*CAL?
Arguments	None
Returns	<NR1> where <NR1>=0 indicates that the internal calibration completed without errors. <NR1>≠0 indicates that the arbitrary/function generator detected an error.
Examples	*CAL? performs an internal calibration and returns results. For example, it might return 0, which indicates that the calibration completed without any errors.

CALibration[:ALL]

The CALibration[:ALL] command performs an internal calibration.

The CALibration[:ALL]? command performs an internal calibration and returns 0 (Pass) or a calibration error code.

NOTE. *The self-calibration can take several minutes to complete. During this time, the arbitrary/function generator does not execute any commands. Do not power off the instrument during the self-calibration.*

Group	Calibration and Diagnostic
Related Commands	*CAL?
Syntax	CALibration[:ALL] CALibration[:ALL]?
Arguments	None
Returns	<NR1>
Examples	CALibration:ALL performs an internal calibration. CALibration:ALL? performs an internal calibration and returns results. For example, it might return 0, which indicates that the calibration completed without any errors.

*CLS (No Query Form)

This command clears all the event registers and queues, which are used in the arbitrary/function generator status and event reporting system.

Group	Status
Syntax	*CLS
Arguments	None
Examples	*CLS clears all the event registers and queues.

DIAGnostic[:ALL]

The `DIAGnostic[:ALL]` command performs a self-test. The `DIAGnostic[:ALL]?` command returns the results after executing the test.

NOTE. *The self-test can take several minutes to complete. During this time, the arbitrary/function generator does not execute any commands. Do not power off the instrument during the self-test.*

Group	Calibration and Diagnostic
Related Commands	*TST?
Syntax	<code>DIAGnostic[:ALL]</code> <code>DIAGnostic[:ALL]?</code>
Arguments	None
Returns	<NR1> where <NR1>=0 indicates that the self-test completed without errors. <NR1>≠0 indicates that the arbitrary/function generator detected an error.
Examples	<code>DIAGnostic:ALL</code> performs self-test. <code>DIAGnostic:ALL?</code> performs self-test and might return an error code.

DISPlay:CONTRast

This command sets or queries the contrast of the LCD display.

Group Display

Syntax DISPlay:CONTRast {<contrast>|MINimum|MAXimum}
DISPlay:CONTRast? [MINimum|MAXimum]

Arguments <contrast>::=<NR2>
where
<NR2> is a range of display contrast from 0.00 through 1.00 (resolution: 3 digits).
The larger the value, the greater the screen contrast.

MINimum sets the display to the 0 contrast level.

MAXimum sets the display to the largest contrast level.

Returns <NR2>

Examples DISPlay:CONTRast MAXimum
sets the display contrast to the largest contrast level.

DISPlay:SAVer:IMMediate (No Query Form)

This command sets the screen saver state to on regardless of the DISPlay:SAVer[:STATe]? command setting.

The screen saver will be enabled immediately (without waiting for five minutes).

Group Display

Related Commands DISPlay:SAVer[:STATe]?

Syntax DISPlay:SAVer:IMMediate

Arguments None

Examples DISPlay:SAVer:IMMediate
sets the screen saver state to on.

DISPlay:SAVer[:STATe]

This command sets or queries the screen saver setting of the LCD display. When enabled, the screen saver function automatically starts if no operations are applied to the instrument front panel for five minutes.

Group Display

Related Commands DISPlay:SAVer:IMMediate

Syntax DISPlay:SAVer[:STATe] {ON|OFF|<NR1>}
DISPlay:SAVer[:STATe]?

Arguments ON or <NR1>≠0 enables the screen saver function.
OFF or <NR1>=0 disables the screen saver function.

Returns <NR1>

Examples DISPlay:SAVer:STATe OFF
disables the screen saver function.

DISPlay[:WINDow]:TEXT[:DATA]

The DISPlay[:WINDow]:TEXT[:DATA] command displays a text message on the instrument screen.

The DISPlay[:WINDow]:TEXT[:DATA]? command returns a text string currently displayed on the instrument screen.

The displayable characters are ASCII code 32 through 126, and the instrument can display approximately 64 characters.

Group	Display
Syntax	DISPlay[:WINDow]:TEXT[:DATA] <string> DISPlay[:WINDow]:TEXT[:DATA]?
Arguments	<string>
Returns	<string> A currently displayed text message is returned.
Examples	DISPlay:WINDow:TEXT:DATA? returns the currently displayed text message.

DISPlay[:WINDow]:TEXT:CLEAr (No Query Form)

This command clears the text message from the display screen.

Group	Display
Syntax	DISPlay[:WINDow]:TEXT:CLEAr
Arguments	None
Examples	DISPlay:WINDow:TEXT:CLEAr clears the text message from the screen.

***ESE**

This command sets or queries the bits in the Event Status Enable Register (ESER) used in the status and events reporting system of the arbitrary/function generator. The query command returns the contents of the ESER.

Group	Status
Related Commands	*CLS, *ESR?, *PSC, *SRE, *STB
Syntax	*ESE <bit_value> *ESE?
Arguments	<bit_value>::=<NR1> where: <NR1> is a value in the range of 0 through 255. The binary bits of the ESER are set according to this value.
Returns	<bit_value>
Examples	*ESE 177 sets the ESER to 177 (binary 10110001), which sets the PON, CME, EXE and OPC bits. *ESE? might return 186, indicating that the ESER contains the binary value 10111010.

***ESR?**

This query-only command returns the contents of the Standard Event Status Register (SESR) used in the status events reporting system in the arbitrary/function generator. *ESR also clears the SESR (since reading the SESR clears it).

Group	Status
Related Commands	*CLS, *ESE?, *SRE, *STB
Syntax	*ESR?
Arguments	None
Returns	<NR1> indicates that the contents of the SESR as a decimal integer.
Examples	*ESR? might return 181, which indicates that the SESR contains the binary number 10110101.

HCOPY:SDUMp[:IMMediate] (No query form)

This command copies a screen image and saves the image file to a USB memory. The default file name is TEK00nnn.BMP, where nnn is a consecutive number from 000 through 999. The image files are saved in a folder named “TEK” in the USB memory.

Group	Screen copy
Syntax	HCOPY:SDUMp[:IMMediate]
Arguments	None
Examples	HCOPY:SDUMp:IMMediate copies the screen image and may create a file TEK00001.BMP in a USB memory.

***IDN?**

This query-only command returns identification information on the arbitrary/function generator.

Group	System
Syntax	*IDN?
Arguments	None
Returns	<Manufacturer>,<Model>,<Serial Number>,<Firmware Level> where: <Manufacturer>::=TEKTRONIX <Model>::={AFG3011 AFG3021B AFG3022B AFG3101 AFG3102 AFG3251 AFG3252} <Serial Number> <Firmware Level>::=SCPI:99.0 FV:2.0
Examples	*IDN? might return the following response: TEKTRONIX,AFG3102,C100101,SCPI:99.0 FV:1.0

MEMory:STATe:VALid?

This query-only command returns the availability of a setup memory.

Group	Memory
Syntax	MEMory:STATe:VALid? {0 1 2 3 4}
Arguments	0, 1, 2, 3, or 4 specifies the location of setup memory.
Returns	<NR1> 1 means that the specified setup memory has been saved. 0 means that the specified setup memory has been deleted.
Examples	MEMory:STATe:VALid? 0 might return 1 if the specified setup memory has been saved.

MEMory:STATe:DELeTe (No Query Form)

This command deletes the contents of specified setup memory. If a specified setup memory is not allowed to overwrite or delete, this command causes an error.

Group	Memory
Syntax	MEMory:STATe:DELeTe {0 1 2 3 4}
Arguments	0, 1, 2, 3, or 4 specifies the location of setup memory.
Examples	MEMory:STATe:DELeTe 1 deletes the contents of specified setup memory.

MEMory:STATe:LOCK

This command sets or queries whether to lock the specified setup memory. If you lock a setup memory, you cannot overwrite or delete the setup file.

You cannot execute this command for the setup memory of location number 0 (last setup memory).

Group	Memory
Syntax	MEMory:STATe:LOCK {1 2 3 4},{ON OFF <NR1>} MEMory:STATe:LOCK?{1 2 3 4}
Arguments	ON or <NR1>≠0 locks the specified location of setup memory. OFF or <NR1>=0 allows you to overwrite or delete the specified location of setup memory.
Returns	<NR1>
Examples	MEMory:STATe:LOCK 1,ON locks the setup memory of location number 1.

MEMory:STATe:RECall:AUTO

This command sets or queries whether to enable the automatic recall of last setup memory when powered-on. The next time you apply the power, the arbitrary/function generator will automatically recall the settings you used when you powered off the instrument.

If you select OFF, the default setups are recalled when you power on the instrument.

Group Memory

Syntax MEMory:STATe:RECall:AUTO {ON|OFF|<NR1>}

MEMory:STATe:RECall:AUTO?

Arguments ON or <NR1>≠0 enables the recall of the setup memory you last used before powering off the instrument.

OFF or <NR1>=0 disables the last setup recall function.

Returns <NR1>

Examples MEMory:STATe:RECall:AUTO ON
sets the instrument to recall the last setup memory when powered-on.

MMEMemory:CATalog?

This query-only command returns the current state of the mass storage system (USB memory).

Group Mass Memory

Related Commands MMEMemory:CDIRectory

Syntax MMEMemory:CATalog?

Arguments None

Returns <NR1>,<NR1>[,<file_name>,<file_type>,<file_size>]...

where:

The first <NR1> indicates that the total amount of storage currently used, in bytes.

The second <NR1> indicates that the free space of mass storage, in bytes.

<file_name> is the exact name of a file.

<file_type> is DIR for directory, otherwise it is blank.

<file_size> is the size of the file, in bytes.

Examples MMEMemory:CATalog?
might return the following response:

```
32751616,27970560,"SAMPLE1.TFS,,5412"
```

MMEMory:CDIRectory

This command changes the current working directory in the mass storage system.

Group Mass Memory

Syntax MMEMory:CDIRectory [<directory_name>]

MMEMory:CDIRectory?

Arguments <directory_name>::=<string> indicates the current working directory for the mass storage system.

If you do not specify a parameter, the directory is set to the *RST value.
At *RST, this parameter is set to the root.

Returns <directory_name>::=<string>

Examples MMEMory:CDIRectory "/AFG/WORK0"
changes the current directory to /AFG/WORK0.

MMEMory:DELeTe (No Query Form)

This command deletes a file or directory from the mass storage system. If a specified file in the mass storage is not allowed to overwrite or delete, this command causes an error. You can delete a directory if it is empty.

Group Mass Memory

Syntax MMEMory:DELeTe <file_name>

Arguments <file_name>::=<string> specifies a file to be deleted.

Examples MMEMory:DELeTe "TEK001.TFW"
deletes the specified file from the mass storage.

MMEMory:LOAD:STATe (No Query Form)

This command copies a setup file in the mass storage system to an internal setup memory. If a specified internal setup memory is locked, this command causes an error.

When you power off the instrument, the setups are automatically overwritten in the setup memory 0 (last setup memory).

Group	Mass Memory
Related Commands	MEMory:STATe:LOCK MEMory:STATe:RECa11:AUTO MMEMory:STORe:STATe
Syntax	MMEMory:LOAD:STATe{0 1 2 3 4},<file_name>
Arguments	0, 1, 2, 3, or 4 specifies the location of setup memory. <file_name>::=<string> specifies a setup file to be copied.
Examples	MMEMory:LOAD:STATe 1,"SETUP1.TFS" copies a file named SETUP1.TFS in the mass storage into the internal memory location 1.

MMEMory:LOAD:TRACe (No Query Form)

This command copies a waveform data file in the mass storage system to Edit Memory. If the file format is different, this command causes an error.

Group	Mass Memory
Related Commands	MMEMory:STORe:TRACe
Syntax	MMEMory:LOAD:TRACe EMEMory,<file_name>
Arguments	<file_name>::=<string> specifies a waveform data file to be copied.
Examples	MMEMory:LOAD:TRACe EMEMory,"TEK001.TFW" copies a file named TEK001.TFW in the mass storage into Edit Memory.

MMEMory:LOCK[:STATe]

This command sets or queries whether to lock a file or directory in the mass storage system. If you lock a file or directory, you cannot overwrite or delete it.

Group Mass Memory

Syntax MMEMory:LOCK[:STATe]<file_name>,{ON|OFF|<NR1>}

MMEMory:LOCK[:STATe]<file_name>?

Arguments ON or <NR1>≠0 locks a file or directory in the mass storage system.

OFF or <NR1>=0 allows you to overwrite or delete a file or directory in the mass storage system.

Returns <NR1>

Examples MMEMory:LOCK[:STATe] "SETUP1.TFS",ON
locks the file "SETUP1.TFS".

MMEMory:MDIRectory (No Query Form)

This command creates a directory in the mass storage system. If the specified directory is locked in the mass storage system, this command causes an error.

Group Mass Memory

Syntax MMEMory:MDIRectory <directory_name>

Arguments <directory_name>::=<string> specifies a directory name to be created.

Examples MMEMory:MDIRectory "SAMPLE1"
creates a directory named "SAMPLE1" in the mass storage system.

MMEMory:STORe:STATe (No Query Form)

This command copies a setup file in the setup memory to a specified file in the mass storage system. If the specified file in the mass storage system is locked, this command causes an error. You cannot create a new file if the directory is locked. If the setup memory is deleted, this command causes an error. <file_name> is a quoted string that defines the file name and path.

Group	Mass Memory
Related Commands	MMEMory:LOAD:STATe MMEMory:LOCK[:STATe]
Syntax	MMEMory:STORe:STATe{0 1 2 3 4},<file_name>
Arguments	0, 1, 2, 3, or 4 specifies the location of setup memory. <file_name>::=<string> specifies a file name in the mass storage system. The <file_name> includes path. Path separators are forward slashes (/).
Examples	MMEMory:STORe:STATe 1,"SETUP1.TFS" Copies the setup file in the setup memory location 1 to a file named "SETUP1.TFS" in the mass storage system.

MMEMory:STORe:TRACe (No Query Form)

This command copies a waveform data file in the Edit Memory to a file in the mass storage system. If the file in the mass storage is locked, this command causes an error. You cannot create a new file if the directory is locked.

Group	Mass Memory
Related Commands	MMEMory:LOCK[:STATe] MMEMory:LOAD:TRACe
Syntax	MMEMory:STORe:TRACe EMEMory,<file_name>
Arguments	<file_name>::=<string> specifies a file name in the mass storage system. The <file_name> includes path. Path separators are forward slashes (/).
Examples	MMEMory:STORe:TRACe EMEMory,"SAMPLE1.TFW" Copies the content of EMEMory to a file named "SAMPLE1.TFW" in the mass storage system.

***OPC**

This command generates the operation complete message by setting bit 0 in the Standard Event Status Register (SESR) when all pending commands that generate an OPC message are complete.

The query command places the ASCII character “1” into the output queue when all such OPC commands are complete.

Group	Synchronization
Syntax	*OPC *OPC?
Arguments	None
Returns	<execution complete>::=1 where “1” indicates that all pending operations are complete.
Examples	*OPC? might return 1 to indicate that all pending OPC operations are finished.

***OPT?**

This query-only command returns a list of the options installed in your arbitrary/function generator.

Group	System
Syntax	*OPT?
Arguments	None
Returns	<OPT>[, <OPT>[, <OPT>[, <OPT>]]]
Examples	*OPT? might return 0, which indicates no option is installed in the instrument.

OUTPut[1|2]:IMPedance

The `OUTPut:IMPedance` command sets the output load impedance for the specified channel. The specified value is used for amplitude, offset, and high/low level settings. You can set the impedance to any value from 1 Ω to 10 k Ω with resolution of 1 Ω or 3 digits. The default value is 50 Ω .

The `OUTPut:IMPedance?` command returns the current load impedance setting in ohms. If the load impedance is set to INFINITY, the query command returns “9.9E+37”.

Group Output

Syntax `OUTPut[1|2]:IMPedance{<ohms>|INFINITY|MINimum|MAXimum}`

`OUTPut[1|2]:IMPedance?[MINimum|MAXimum]`

Arguments `<ohms>::=<NR3>[<units>]`

where

`<units>::=OHM`

INFINITY sets the load impedance to >10 k Ω .

MINimum sets the load impedance to 1 Ω .

MAXimum sets the load impedance to 10 k Ω .

Returns `<ohms>::=<NR3>`

Examples `OUTPut1:IMPedance MAXimum`
sets the CH 1 load impedance to 10 k Ω .

OUTPut[1|2]:POLarity

This command inverts a specified output waveform relative to the offset level. The query command returns the polarity for the specified channel.

Group Output

Syntax OUTPut[1|2]:POLarity{NORMal|INVerted}

OUTPut[1|2]:POLarity?

Arguments NORMal sets the specified output waveform polarity to Normal.

INVerted sets the specified output waveform polarity to Inverted.

Returns NORM|INV

Examples OUTPut1:POLarity NORMal
sets the CH 1 waveform polarity to Normal.

OUTPut[1|2][:STATe]

This command sets or query whether to enable the arbitrary/function generator output for the specified channel.

Group Output

Syntax OUTPut[1|2][:STATe] {ON|OFF|<NR1>}

OUTPut[1|2][:STATe]?

Arguments ON or <NR1>≠0 enables the arbitrary/function generator output.

OFF or <NR1>=0 disables the arbitrary/function generator output.

Returns <NR1>

Examples OUTPut1:STATe ON
sets the arbitrary/function generator CH 1 output to ON.

OUTPut:TRIGger:MODE

This command sets or queries the mode (trigger or sync) for Trigger Output signal.

When the burst count is set to Inf-Cycles in burst mode, TRIGger indicates that the infinite number of cycles of waveform will be output from the Trigger Output connector.

When the burst count is set to Inf-Cycles in burst mode, SYNC indicates that one pulse waveform is output from the Trigger Output connector when the Inf-Cycles starts.

When Run Mode is specified other than Burst Inf-Cycles, TRIGger and SYNC have the same effect.

Group Output

Syntax OUTPut:TRIGger:MODE {TRIGger|SYNC}

OUTPut:TRIGger:MODE?

Arguments TRIGger means TRIGger is selected for Trigger Out.

SYNC means SYNC is selected for Trigger Out.

Returns TRIG|SYNC

Examples OUTPut:TRIGger:MODE SYNC
outputs one cycle waveform from the Trigger Output connector when Inf-Cycles starts.

***PSC**

This command sets and queries the power-on status flag that controls the automatic power-on execution of SRER and ESER. When *PSC is true, SRER and ESER are set to 0 at power-on. When *PSC is false, the current values in the SRER and ESER are preserved in nonvolatile memory when power is shut off and are restored at power-on.

Group Status

Syntax *PSC <NR1>

*PSC?

Arguments <NR1>=0 sets the power-on status clear flag to false, disables the power-on clear, and allows the instrument to possibly assert SRQ after power-on.

<NR1>≠0 sets the power-on status clear flag true. Sending *PSC 1 therefore enables the power-on status clear and prevents any SRQ assertion after power-on.

Returns <NR1>

Examples *PSC 0
sets the power-on status clear flag to false.

***RCL (No Query Form)**

This command restores the state of the instrument from a copy of the settings stored in the setup memory. The settings are stored using the *SAV command. If the specified setup memory is deleted, this command causes an error.

Group Memory

Related Commands *SAV

Syntax *RCL {0|1|2|3|4}

Arguments 0, 1, 2, 3, or 4 specifies the location of setup memory.

Examples *RCL 3
restores the instrument from a copy of the settings stored in memory location 3.

*RST (No Query Form)

This command resets the instrument to the factory default settings. This command is equivalent to pushing the **Default** button on the front panel. The default values are listed in *Default Settings* on page D-1.

Group	System
Syntax	*RST
Arguments	None
Examples	*RST resets the arbitrary/function generator settings to the factory defaults.

*SAV (No Query Form)

This command stores the current settings of the arbitrary/function generator to a specified setup memory location.

A setup memory location numbered 0 (last setup memory) is automatically overwritten by the setups when you power off the instrument.

If a specified numbered setup memory is locked, this command causes an error.

Group	Memory
Related Commands	*RCL
Syntax	*SAV {0 1 2 3 4}
Arguments	0, 1, 2, 3, or 4 specifies the location of setup memory.
Examples	*SAV 2 saves the current instrument state in the memory location 2.

[SOURce[1|2]]:AM[:DEPTh]

This command sets or queries the modulation depth of AM modulation for the specified channel. You can set the modulation depth from 0.0% to 120.0% with resolution of 0.1%.

Group Source

Syntax [SOURce[1|2]]:AM:DEPTh{<depth>|MINimum|MAXimum}

[SOURce[1|2]]:AM:DEPTh?[MINimum|MAXimum]

Arguments <depth>::=<NR2>[<units>]

where

<NR2> is the depth of modulating frequency.

<units>::=PCT

MINimum sets the modulation depth to minimum value.

MAXimum sets the modulation depth to maximum value.

Returns <depth>

Examples SOURce1:AM:DEPTh MAXimum
sets the depth of modulating signal on CH 1 to the maximum value.

[SOURce[1|2]]:AM:INTernal:FREQuency

This command sets or queries the internal modulation frequency of AM modulation for the specified channel. You can use this command only when the internal modulation source is selected. You can set the internal modulation frequency from 2 mHz to 50.00 kHz with resolution of 1 mHz.

You can select the source of modulating signal by using the [SOURce[1|2]]:AM:SOURce [INTernal|EXTernal] command.

Group	Source
Related Commands	[SOURce[1 2]]:AM:SOURce
Syntax	[SOURce[1 2]]:AM:INTernal:FREQuency{<frequency> MINimum MAXimum} [SOURce[1 2]]:AM:INTernal:FREQuency?[MINimum MAXimum]
Arguments	<frequency>::=<NRf>[<units>] where <NRf> is the modulation frequency. <units>::=[Hz kHz MHz]
Returns	<frequency>
Examples	SOURce1:AM:INTernal:FREQuency 10kHz sets the CH 1 internal modulation frequency to 10 kHz.

[SOURce[1|2]]:AM:INTernal:FUNCTion

This command sets or queries the modulating waveform of AM modulation for the specified channel. You can use this command only when the internal modulation source is selected.

If you specify EFILE when there is no EFILE or the EFILE is not yet defined, this command causes an error.

Group Source

Related Commands [SOURce[1|2]]:AM:SOURce
[SOURce[1|2]]:AM:INTernal:FUNCTion:EFILE

Syntax [SOURce[1|2]]:AM:INTernal:FUNCTion {SINusoid|SQUare|TRIangle|RAMP|NRAMP|PRNoise|USER[1]|USER2|USER3|USER4|EMEMory|EFILE}

[SOURce[1|2]]:AM:INTernal:FUNCTion?

Arguments SINusoid|SQUare|TRIangle|RAMP|NRAMP|PRNoise
One of six types of function waveform can be selected as a modulating signal.

USER[1]|USER2|USER3|USER4|EMEMory
A user defined waveform saved in the user waveform memory or the EMEMory can be selected as a modulating signal.

EFILE
EFILE is used as a modulating signal.

Returns SIN|SQU|TRI|RAMP|NRAMP|PRN|USER1|USER2|USER3|USER4|EMEMory|EFILE

Examples SOURce1:AM:INTernal:FUNCTion SQUare
selects Square as the shape of modulating waveform for the CH 1 output.

[SOURce[1|2]]:AM:INTernal:FUNCTion:EFILe

This command sets or queries an EFILe name used as a modulating waveform for AM modulation. A file name must be specified in the mass storage system. This command returns “ ” if there is no file in the mass storage.

Group	Source
Syntax	[SOURce[1 2]]:AM:INTernal:FUNCTion:EFILe <file_name> [SOURce[1 2]]:AM:INTernal:FUNCTion:EFILe?
Arguments	<file_name>::=<string> specifies a file name in the mass storage system. The <file_name> includes path. Path separators are forward slashes (/).
Returns	<file_name>
Examples	SOURce1:AM:INTernal:FUNCTion:EFILe “SAMPLE1” sets a file named “SAMPLE1” in the mass storage.

[SOURce[1|2]]:AM:SOURce

This command sets or queries the source of modulating signal of AM modulation for the specified channel.

Group	Source
Syntax	[SOURce[1 2]]:AM:SOURce [INTernal EXTernal] [SOURce[1 2]]:AM:SOURce?
Arguments	INTernal means that the carrier waveform is modulated with an internal source. EXTernal means that the carrier waveform is modulated with an external source.
Returns	INT EXT
Examples	SOURce1:AM:SOURce INTernal sets the CH 1 source of modulating signal to internal.

[SOURce[1|2]]:AM:STATe

This command enables or disables AM modulation for the specified channel. The query command returns the state of AM modulation.

Group Source

Syntax [SOURce[1|2]]:AM:STATe {ON|OFF|<NR1>}

[SOURce[1|2]]:AM:STATe?

Arguments ON or <NR1>≠0 enables AM modulation.

OFF or <NR1>=0 disables AM modulation.

Returns <NR1>

Examples SOURce1:AM:STATe ON
enables the CH 1 AM modulation.

[SOURce[1|2]]:BURSt:MODE

This command sets or queries the burst mode for the specified channel.

Group Source

Syntax [SOURce[1|2]]:BURSt:MODE{TRIGgered|GATed}

[SOURce[1|2]]:BURSt:MODE?

Arguments TRIGgered means that triggered mode is selected for burst mode.

GATed means that gated mode is selected for burst mode.

Returns TRIG|GAT

Examples SOURce1:BURSt:MODE TRIGgered
selects triggered mode.

[SOURce[1|2]]:BURSt:NCYCles

This command sets or queries the number of cycles (burst count) to be output in burst mode for the specified channel. The query command returns 9.9E+37 if the burst count is set to INFINITY.

Group Source

Syntax [SOURce[1|2]]:BURSt:NCYCles {<cycles>|INFINITY|MINimum|MAXimum}

[SOURce[1|2]]:BURSt:NCYCles? [MINimum|MAXimum]

Arguments <cycles>::=<NRf>

where

<NRf> is the burst count.

The burst count ranges from 1 to 1,000,000.

INFINITY sets the burst count to infinite count.

MINimum sets the burst count to minimum count.

MAXimum sets the burst count to maximum count.

Returns <cycles>

Examples SOURce1:BURSt:NCYCles 2
sets the CH 1 burst count to 2.

[SOURce[1|2]]:BURSt[:STATe]

This command enables or disables the burst mode for the specified channel. The query command returns the state of burst mode.

Group Source

Syntax [SOURce[1|2]]:BURSt:STATe {ON|OFF|<NR1>}

[SOURce[1|2]]:BURSt:STATe?

Arguments ON or <NR1>≠0 enables the burst mode.

OFF or <NR1>=0 disables the burst mode.

Returns <NR1>

Examples SOURce1:BURSt:STATe ON
enables the burst mode for the CH 1.

[SOURce[1|2]]:BURSt:TDELaY

This command sets or queries delay time in the burst mode for the specified channel. It specifies a time delay between the trigger and the signal output. This command is available only in the Triggered burst mode.

The setting range is 0.0 ns to 85.000 s with resolution of 100 ps or 5 digits.

Group Source

Syntax [SOURce[1|2]]:BURSt:TDELaY {<deLaY>|MINimum|MAXimum}
[SOURce[1|2]]:BURSt:TDELaY? [MINimum|MAXimum]

Arguments <deLaY>::=<NRf>[<units>]
where
<units>::=[s | ms | μ s | ns]

MINimum sets the delay time to minimum value.

MAXimum sets the delay time to maximum value.

Returns <deLaY>

Examples SOURce1:BURSt:DELaY 20ms
sets the CH 1 delay time to 20 ms.

[SOURce[1|2]]:COMBine:FEED

This command sets or queries whether to add the internal noise or an external signal to an output signal for the specified channel.

When you specify the internal noise, you can set or query the noise level by SOURce<3|4>:POWer[:LEVel][:IMMediate][:AMPLitude] command.

To disable the internal noise add or the external signal add function, specify “”.

You can add an external signal to the CH 1 output signal of the AFG3100 and AFG3200 series arbitrary/function generators.

The CH 2 output is not available for adding external signal.

Both the internal noise and an external signal can be added simultaneously to the arbitrary/function generator.

Group Source

Related Commands SOURce<3|4>:POWer[:LEVel][:IMMediate][:AMPLitude]

Syntax [SOURce[1]]:COMBine:FEED [“NOISe”|“EXTernal”|“BOTH”|“”]
SOURce2:COMBine:FEED [“NOISe”|“”]
[SOURce[1|2]]:COMBine:FEED?

Arguments NOISe indicates that the internal noise is added to the output signal.
EXTernal indicates that an external signal is added to the CH 1 output signal of the AFG3100 or AFG3200 series arbitrary/function generators.
BOTH indicates that the internal noise and an external signal are added to the CH 1 output signal of the AFG3100 or AFG3200 series arbitrary/function generators.
“” disables the internal noise add and external signal add function.

Returns “NOIS”|“EXT”|“BOTH”|“”

Examples SOURce1:COMBine:FEED EXTernal
adds an external signal to the CH 1 output signal.

[SOURce[1|2]]:FM[:DEVIation]

This command sets or queries the peak frequency deviation of FM modulation for the specified channel. The setting range of frequency deviation depends on the waveform selected as the carrier. For more information, refer to the specifications page of Quick Start User Manual.

Group Source

Syntax [SOURce[1|2]]:FM:DEVIation {<deviation>|MINimum|MAXimum}

[SOURce[1|2]]:FM:DEVIation?[MINimum|MAXimum]

Arguments <deviation>::=<NRf>[<units>]
where
<NRf> is the frequency deviation.
<units>::=[Hz | kHz | MHz]

Returns <deviation>

Examples SOURce1:FM:DEVIation 1.0MHz
sets the CH 1 frequency deviation to 1.0 MHz.

[SOURce[1|2]]:FM:INTernal:FREQuency

This command sets or queries the internal modulation frequency of FM modulation for the specified channel. You can use this command only when the internal modulation source is selected.

You can set the internal modulation frequency from 2 mHz to 50.00 kHz with resolution of 1 mHz.

You can select the source of modulating signal by using the [SOURce[1|2]]:FM:SOURce [INTernal|EXTernal] command.

Group Source

Related Commands [SOURce[1|2]]:FM:SOURce

Syntax [SOURce[1|2]]:FM:INTernal:FREQuency {<frequency>|MINimum|MAXimum}
[SOURce[1|2]]:FM:INTernal:FREQuency? [MINimum|MAXimum]

Arguments <frequency>::=<NRf>[<units>]
where
<NRf> is the modulation frequency.
<units>::=[Hz | kHz | MHz]

Returns <frequency>

Examples SOURce1:FM:INTernal:FREQuency 10kHz
sets the CH 1 internal modulation frequency to 10 kHz.

[SOURce[1|2]]:FM:INTernal:FUNCTion

This command sets or queries the modulating waveform of FM modulation for the specified channel. You can use this command only when the internal modulation source is selected.

If you specify EFILE when there is no EFILE or the EFILE is not yet defined, this command causes an error.

Group Source

Related Commands [SOURce[1|2]]:FM:SOURce

Syntax [SOURce[1|2]]:FM:INTernal:FUNCTion{SINusoid|SQUare|TRIangle|RAMP|NRAMP|PRNoise|USER[1]|USER2|USER3|USER4|EMEMory|EFILE}

[SOURce[1|2]]:FM:INTernal:FUNCTion?

Arguments SINusoid|SQUare|TRIangle|RAMP|NRAMP|PRNoise
One of six types of function waveform can be selected as a modulating signal.

USER[1]|USER2|USER3|USER4|EMEMory
A user defined waveform saved in the user waveform memory or the EMEMory can be selected as a modulating signal.

EFILE
EFILE is used as a modulating signal.

Returns SIN|SQU|TRI|RAMP|NRAMP|PRN|USER1|USER2|USER3|USER4|EMEMory|EFILE

Examples SOURce1:FM:INTernal:FUNCTion SQUare
selects Square as the shape of modulating waveform for the CH 1 output.

[SOURce[1|2]]:FM:INTernal:FUNction:EFILe

This command sets or queries an EFILe name used as a modulating waveform for FM modulation. A file name must be specified in the mass storage system. This command returns “ ” if there is no file in the mass storage.

Group Source

Syntax [SOURce[1|2]]:FM:INTernal:FUNction:EFILe <file_name>

[SOURce[1|2]]:FM:INTernal:FUNction:EFILe?

Arguments <file_name>::=<string> specifies a file name in the mass storage system. The <file_name> includes path. Path separators are forward slashes (/).

Returns <file_name>

Examples SOURce1:FM:INTernal:FUNction:EFILe “SAMPLE1”
sets a file named “SAMPLE1” in the mass storage.

[SOURce[1|2]]:FM:SOURce

This command sets or queries the source of modulating signal of FM modulation for the specified channel.

Group Source

Syntax [SOURce[1|2]]:FM:SOURce [INTernal|EXTernal]

[SOURce[1|2]]:FM:SOURce?

Arguments INTernal means that the carrier waveform is modulated with the internal source.

EXTernal means that the carrier waveform is modulated with an external source.

Returns INT|EXT

Examples SOURce1:FM:SOURce INTernal
sets the CH 1 source of modulating signal to internal.

[SOURce[1|2]]:FM:STATe

This command enables or disables FM modulation. The query command returns the state of FM modulation.

Group Source

Syntax [SOURce[1|2]]:FM:STATe {ON|OFF|<NR1>}

[SOURce[1|2]]:FM:STATe?

Arguments ON or <NR1>≠0 enables FM modulation.

OFF or <NR1>=0 disables FM modulation.

Returns <NR1>

Examples SOURce1:FM:STATe ON
enables the CH 1 FM modulation.

[SOURce[1|2]]:FREQUENCY:CENTer

This command sets or queries the center frequency of sweep for the specified channel. This command is always used with the [SOURce[1|2]]:FREQUENCY:SPAN command. The setting range of center frequency depends on the waveform selected for sweep.

Group Source

Related Commands [SOURce[1|2]]:FREQUENCY:SPAN
[SOURce[1|2]]:FREQUENCY:MODE

Syntax [SOURce[1|2]]:FREQUENCY:CENTer {<frequency>|MINimum|MAXimum}
[SOURce[1|2]]:FREQUENCY:CENTer?

Arguments <frequency>::=<NRF>[<units>]
where
<NRF> is the center frequency.
<units>::=[Hz | kHz | MHz]

Returns <frequency>

Examples SOURce1:FREQUENCY:CENTer 550kHz
sets the CH 1 center frequency to 550 kHz.

[SOURce[1|2]]:FREQuency:CONCurent[:STATe]

This command enables or disables the function to copy the frequency (or period) of one channel to another channel.

The [SOURce[1|2]]:FREQuency:CONCurent command copies the frequency (or period) of the channel specified by the header suffix to another channel. If you specify CH 1 with the header, the CH 1 frequency will be copied to CH 2.

The [SOURce[1|2]]:FREQuency:CONCurent? command returns “0” (off) or “1” (on).

If your arbitrary/function generator is single-channel model, this command is not supported.

Group Source

Syntax [SOURce[1|2]]:FREQuency:CONCurent {ON|OFF|<NR1>}
[SOURce[1|2]]:FREQuency:CONCurent?

Arguments ON or <NR1>≠0 enables the concurrent copy function.
OFF or <NR1>=0 disables the concurrent copy function.

Returns <NR1>

Examples SOURce1:FREQuency:CONCurent ON
copies the frequency value of CH 1 to CH 2.

[SOURce[1|2]]:FREQuency[:CW|:FIXed]

This command sets or queries the frequency of output waveform for the specified channel. This command is available when the Run Mode is set to other than Sweep.

The setting range of output frequency depends on the type of output waveform. If you change the type of output waveform, it might change the output frequency because changing waveform types impacts on the setting range of output frequency. The resolution is 1 μ Hz or 12 digits. For more information on the setting range, refer to the specifications page of Quick Start User Manual.

Group Source

Syntax [SOURce[1|2]]:FREQuency[:CW|:FIXed] {<frequency>|MINimum|MAXimum}

[SOURce[1|2]]:FREQuency[:CW|:FIXed]?[MINimum|MAXimum]

Arguments <frequency>::=<NRf>[<units>]
where
<NRf> is the output frequency.
<units>::=[Hz | kHz | MHz]

Returns <frequency>

Examples SOURce1:FREQuency:FIXed 500kHz
sets the CH 1 output frequency to 500 kHz when the Run Mode is set to other than Sweep.

[SOURce[1|2]]:FREQuency:MODE

This command sets or queries the frequency sweep state. You can select sine, square, ramp, or arbitrary waveform for sweep. The arbitrary/function generator automatically changes to the Continuous mode if any waveform is selected other than sine, square, ramp, or an arbitrary waveform.

Group Source

Related Commands [SOURce[1|2]]:FREQuency[:CW|:FIXed]
 [SOURce[1|2]]:FREQuency:CENTer
 [SOURce[1|2]]:FREQuency:SPAN
 [SOURce[1|2]]:FREQuency:START
 [SOURce[1|2]]:FREQuency:STOP

Syntax [SOURce[1|2]]:FREQuency:MODE {CW|FIXed|SWEep}

[SOURce[1|2]]:FREQuency:MODE?

Arguments CW|FIXed means that the frequency is controlled by the [SOURce[1|2]]:FREQuency[:CW|:FIXed] command. The sweep is invalid.

SWEep means that the output frequency is controlled by the sweep command set. The sweep is valid.

Returns CW|FIXed|SWEep

Examples SOURce1:FREQuency:MODE SWEep
 specifies the sweep command set for controlling the CH 1 output frequency.

[SOURce[1|2]]:FREQuency:SPAN

This command sets or queries the span of frequency sweep for the specified channel. This command is always used with the [SOURce[1|2]]:FREQuency:CENTer command. The setting range of frequency span depends on the waveform selected for sweep.

Group Source

Related Commands [SOURce[1|2]]:FREQuency:CENTer
[SOURce[1|2]]:FREQuency:MODE

Syntax [SOURce[1|2]]:FREQuency:SPAN {<frequency>|MINimum|MAXimum}
[SOURce[1|2]]:FREQuency:SPAN? [MINimum|MAXimum]

Arguments <frequency>::=<NRf>[<units>]
where
<NRf> is the frequency span.
<units>::=[Hz | kHz | MHz]

Returns <frequency>

Examples SOURce1:FREQuency:SPAN 900 kHz
sets the CH 1 frequency span to 900 kHz.

[SOURce[1|2]]:FREQuency:STARt

This command sets or queries the start frequency of sweep for the specified channel. This command is always used with the [SOURce[1|2]]:FREQuency:STOP command. The setting range of start frequency depends on the waveform selected for sweep. For more information on the setting range, refer to the specifications page of Quick Start User Manual.

Group Source

Related Commands [SOURce[1|2]]:FREQuency:MODE
[SOURce[1|2]]:FREQuency:STOP

Syntax [SOURce[1|2]]:FREQuency:STARt {<frequency>|MINimum|MAXimum}
[SOURce[1|2]]:FREQuency:STARt? [MINimum|MAXimum]

Arguments <frequency>::=<NRf>[<units>]
where
<NRf> is the start frequency.
<units>::=[Hz | kHz | MHz]

Returns <frequency>

Examples SOURce1:FREQuency:STARt 10kHz
sets the sweep start frequency of CH 1 to 10 kHz.

[SOURce[1|2]]:FREQuency:STOP

This command sets or queries the start frequency of sweep for the specified channel. This command is always used with the [SOURce[1|2]]:FREQuency:START command. The setting range of stop frequency depends on the waveform selected for sweep. For more information on the setting range, refer to the specifications page of Quick Start User Manual.

Group Source

Related Commands [SOURce[1|2]]:FREQuency:MODE
[SOURce[1|2]]:FREQuency:START

Syntax [SOURce[1|2]]:FREQuency:STOP {<frequency>|MINimum|MAXimum}
[SOURce[1|2]]:FREQuency:STOP? [MINimum|MAXimum]

Arguments <frequency>::=<NRf>[<units>]
where
<NRf> is the stop frequency.
<units>::=[Hz | kHz | MHz]

Returns <frequency>

Examples SOURce1:FREQuency:STOP 100KHz
sets the stop frequency of CH 1 to 100 kHz.

[SOURce[1|2]]:FSKey:FREQuency]

This command sets or queries the hop frequency of FSK modulation for the specified channel.

Group Source

Syntax [SOURce[1|2]]:FSKey[:FREQuency] {<frequency>|MINimum|MAXimum}

[SOURce[1|2]]:FSKey[:FREQuency]? [MINimum|MAXimum]

Arguments <frequency>::=<NRf>[<units>]

where

<NRf> is the hop frequency.

<units>::=[Hz | kHz | MHz]

Returns <frequency>

Examples SOURce1:FSKey:FREQuency 1.0MHz
sets the hop frequency of CH 1 FSK modulation to 1.0 MHz.

[SOURce[1|2]]:FSKey:INTernal:RATE

This command sets or queries the internal modulation rate of FSK modulation for the specified channel. You can use this command only when the internal modulation source is selected.

Group Source

Syntax [SOURce[1|2]]:FSKey:INTernal:RATE {<rate>|MINimum|MAXimum}

[SOURce[1|2]]:FSKey:INTernal:RATE? [MINimum|MAXimum]

Arguments <rate>::=<NRf>[<units>]

where

<NRf> is the modulation rate.

<units>::=[Hz | kHz | MHz]

Returns <rate>

Examples SOURce1:FSKey:INTernal:RATE 50Hz
sets the CH 1 internal modulation rate to 50 Hz.

[SOURce[1|2]]:FSKey:SOURce

This command sets or queries the source of modulation signal of FSK modulation for the specified channel.

Group Source

Syntax [SOURce[1|2]]:FSKey:SOURce [INTerna1|EXTerna1]

[SOURce[1|2]]:FSKey:SOURce?

Arguments INTerna1 means that the carrier waveform is modulated with an internal source.

EXTerna1 means that the carrier waveform is modulated with an external source.

Returns INT|EXT

Examples SOURce1:FSKey:SOURce INTerna1
sets the CH 1 source of modulating signal to internal.

[SOURce[1|2]]:FSKey:STATE

This command enables or disables FSK modulation. The query command returns the state of FSK modulation. You can select a sine, square, ramp, or arbitrary waveform for the carrier waveform.

Group Source

Syntax [SOURce[1|2]]:FSKey:STATE {ON|OFF|<NR1>}

[SOURce[1|2]]:FSKey:STATE?

Arguments ON or <NR1>≠0 enables FSK modulation.

OFF or <NR1>=0 disables FSK modulation.

Returns <NR1>

Examples SOURce1:FSKey:STATE ON
enables the CH 1 FSK modulation.

[SOURce[1|2]]:FUNction:EFILe

This command sets or queries an EFILE name used as an output waveform. A file name must be specified in the mass storage system. This command returns “ ” if there is no file in the mass storage.

Group	Source
Syntax	[SOURce[1 2]]:FUNction:EFILe <file_name> [SOURce[1 2]]:FUNction:EFILe?
Arguments	<file_name>::=<string> specifies a file name in the mass storage system. The <file_name> includes path. Path separators are forward slashes (/).
Returns	<file_name>
Examples	SOURce1:FUNction:EFILe “SAMPLE1” sets a file named “SAMPLE1” in the mass storage.

[SOURce[1|2]]:FUNction:RAMP:SYMMetry

This command sets or queries the symmetry of ramp waveform for the specified channel. The setting range is 0.0% to 100.0%.

Group	Source
Syntax	[SOURce[1 2]]:FUNction:RAMP:SYMMetry {<symmetry> MINimum MAXimum} [SOURce[1 2]]:FUNction:RAMP:SYMMetry? [MINimum MAXimum]
Arguments	<symmetry>::=<NR2>[<units>] where <NR2> is the symmetry. <units>::=PCT
Returns	<symmetry>
Examples	SOURce1:FUNction:RAMP:SYMMetry 80.5 sets the symmetry of the CH 1 ramp waveform to 80.5%.

[SOURce[1|2]]:FUNCTion[:SHAPE]

This command sets or queries the shape of the output waveform. When the specified user memory is deleted, this command causes an error if you select the user memory.

Group Source

Syntax [SOURce[1|2]]:FUNCTion[:SHAPE] {SINusoid|SQUare|PULSe|RAMP|PRNoise|DC|SINC|GAUSSian|LOREntz|ERISe|EDECaY|HAVersine|USER[1]|USER2|USER3|USER4|EMEMory|EFILe}

[SOURce[1|2]]:FUNCTion[:SHAPE]?

Arguments SINusoid|SQUare|PULSe|RAMP|PRNoise|DC|SINC|GAUSSian|LOREntz|ERISe|EDECaY|HAVersine

The following table shows the combination of modulation type and the shape of output waveform.

	Sine, Square, Ramp, Arb, Sin(x)/x, Gaussian, Lorentz, Exponential Rise, Exponential Decay, Haversine	Pulse	Noise, DC
AM	√		
FM	√		
PM	√		
FSK	√		
PWM		√	
Sweep	√		
Burst	√	√	

If you select a waveform shape that is not allowed with a particular modulation, sweep, or burst, the Run mode will automatically be changed to Continuous.

If you specify EFILe when there is no EFILe or the EFILe is not yet defined, this command causes an error.

If you change the type of output waveform, it might change the output frequency because changing waveform types impacts the setting range of output frequency.

USER[1]|USER2|USER3|USER4|EMEMory

A user defined waveform saved in the user waveform memory or the EMEMory can be selected as an output waveform.

EFILe
EFILe is specified as an output waveform.

Returns SIN|SQU|PULS|RAMP|PRN|DC|SINC|GAUS|LOR|ERIS|EDEC|HARV|USER1|USER2
|USER3|USER4|EMEMory|EFILe

Examples SOURce1:FUNcTion:SHApe SQUare
selects the shape of CH 1 output waveform to square waveform.

[SOURce[1|2]]:PHASe[:ADJust]

This command sets or queries the phase of output waveform for the specified channel. You can set the value in radians or degrees. If no units are specified, the default is RAD. The query command returns the value in RAD.

This command is supported when you select a waveform other than DC, Noise, and Pulse.

Group Source

Syntax [SOURce[1|2]]:PHASe[:ADJust] {<phase>|MINimum|MAXimum}
[SOURce[1|2]]:PHASe[:ADJust]? [MINimum|MAXimum]

Arguments <phase>::=<NR3>[<units>]
where
<NR3> is the phase of output frequency.
<units>::=[RAD | DEG]

If <units> are omitted, RAD is specified automatically. The setting ranges are:

RAD -1 PI to +1 PI, relative to phase value
DEG -180 to +180, relative to phase value

Returns <phase>

Examples SOURce1:PHASe:ADJust MAXimum
sets the maximum value for the phase of CH 1 output frequency.

[SOURce[1|2]]:PHASe:INITiate (No Query Form)

This command synchronizes the phase of CH 1 and CH 2 output waveforms. The arbitrary/function generator performs the same operation if you specify either SOURce1 or SOURce2.

If your arbitrary/function generator is single-channel model, this command is not supported.

Group	Source
Syntax	[SOURce[1 2]]:PHASe:INITiate
Arguments	None
Examples	SOURce1:PHASe:INITiate synchronizes the phase of CH 1 and CH 2 output signals.

[SOURce[1|2]]:PM[:DEVIation]

This command sets or queries the peak frequency deviation of PM modulation for the specified channel.

Group	Source
Syntax	[SOURce[1 2]]:PM:DEVIation {<deviation> MINimum MAXimum} [SOURce[1 2]]:PM:DEVIation? [MINimum MAXimum]
Arguments	<deviation>::=<NR3>[<units>] where <NR3> is the phase deviation. <units>::=[RAD DEG] If <units> are omitted, RAD is specified automatically. The setting ranges are: RAD 0 PI to +1 PI, relative to phase value DEG 0 to +180, in 1 degree steps, relative to phase value
Returns	<deviation>
Examples	SOURce1:PM:DEVIation MAXimum sets the maximum value for the CH 1 phase deviation.

[SOURce[1|2]]:PM:INTernal:FREQuency

This command sets or queries the internal modulation frequency of PM modulation for the specified channel. You can use this command only when the internal modulation source is selected.

You can set the internal modulation frequency from 2 mHz to 50.00 kHz with resolution of 1 mHz.

You can select the source of modulating signal by using the [SOURce[1|2]]:PM:SOURce [INTernal|EXTernal] command.

Group	Source
Related Commands	[SOURce[1 2]]:PM:SOURce
Syntax	[SOURce[1 2]]:PM:INTernal:FREQuency {<frequency> MINimum MAXimum} [SOURce[1 2]]:PM:INTernal:FREQuency? [MINimum MAXimum]
Arguments	<frequency>::=<NRf>[<units>] where <NRf> is the modulation frequency. <units>::=[Hz kHz MHz]
Returns	<frequency>
Examples	SOURce1:PM:INTernal:FREQuency 10kHz sets the CH 1 internal modulation frequency to 10 kHz.

[SOURce[1|2]]:PM:INTernal:FUNCTion

This command sets or queries the modulating waveform of PM modulation for the specified channel. You can use this command only when the internal modulation source is selected.

If you specify EFILe when there is no EFILe or the EFILe is not yet defined, this command causes an error.

Group Source

Related Commands [SOURce[1|2]]:PM:SOURce

Syntax [SOURce[1|2]]:PM:INTernal:FUNCTion {SINusoid|SQUare|TRIangle|
RAMP|NRAMP|PRNoise|USER[1]|USER2|USER3|USER4|EMEMory|EFILe}

[SOURce[1|2]]:PM:INTernal:FUNCTion?

Arguments SINusoid|SQUare|TRIangle|RAMP|NRAMP|PRNoise
One of six types of function waveform can be selected as a modulating signal.

USER[1]|USER2|USER3|USER4|EMEMory
A user defined waveform saved in the user waveform memory or the EMEMory can be selected as a modulating signal.

EFILe
EFILe is used as a modulating signal.

Returns SIN|SQU|TRI|RAMP|NRAMP|PRN|USER1|USER2|USER3|USER4|EMEMory|EFILe

Examples SOURce1:PM:INTernal:FUNCTion SQUare
selects Square as the shape of modulating waveform for the CH 1 output.

[SOURce[1|2]]:PM:INTernal:FUNCTion:EFILe

This command sets or queries an EFILe name used as a modulating waveform for PM modulation. A file name must be specified in the mass storage system. This command returns “ ” if there is no file in the mass storage.

Group	Source
Syntax	[SOURce[1 2]]:PM:INTernal:FUNCTion:EFILe <file_name> [SOURce[1 2]]:PM:INTernal:FUNCTion:EFILe?
Arguments	<file_name>::=<string> specifies a file name in the mass storage system. The <file_name> includes path. Path separators are forward slashes (/).
Returns	<file_name>
Examples	SOURce1:PM:INTernal:FUNCTion:EFILe “SAMPLE1” sets a file named “SAMPLE1” in the mass storage.

[SOURce[1|2]]:PM:SOURce

This command sets or queries the source of modulation signal of PM modulation for the specified channel.

Group	Source
Syntax	[SOURce[1 2]]:PM:SOURce [INTernal EXTernal] [SOURce[1 2]]:PM:SOURce?
Arguments	INTernal means that the carrier waveform is modulated with an internal source. EXTernal means that the carrier waveform is modulated with an external source.
Returns	INT EXT
Examples	SOURce1:PM:SOURce INTernal sets the CH 1 source of modulating signal to internal.

[SOURce[1|2]]:PM:STATe

This command enables or disables PM modulation. The query command returns the state of PM modulation. You can select a sine, square, ramp, or arbitrary waveform for the carrier waveform.

Group Source

Syntax [SOURce[1|2]]:PM:STATe {ON|OFF|<NR1>}

[SOURce[1|2]]:PM:STATe?

Arguments ON or <NR1>≠0 enables PM modulation.

OFF or <NR1>=0 disables PM modulation.

Returns <NR1>

Examples SOURce1:PM:STATe ON
enables the CH 1 PM modulation.

SOURce<3|4>:POWER[:LEVel][:IMMediate][:AMPLitude]

This command sets or queries the internal noise level which applies to the output signal for the specified channel. The noise level represents the percent against current amplitude level. The setting range is 0 to 50%.

This command is available when Run Mode is set to Continuous, Burst, or Sweep.

You can set or query whether to add the internal noise to the output signal using the [SOURce[1|2]]:COMBine:FEED command.

Group Source

Related Commands [SOURce[1|2]]:COMBine:FEED

Syntax SOURce<3|4>:POWER[:LEVel][:IMMediate][:AMPLitude] {<percent>|MINimum|MAXimum}

SOURce<3|4>:POWER[:LEVel][:IMMediate][:AMPLitude]?[MINimum|MAXimum]

Arguments <percent>::=<NR2>[<units>]
where
<NR2> is the noise level.
<units>::=PCT

Returns <percent>

Examples SOURce3:POWER:LEVel:IMMediate:AMPLitude 50PCT
sets the internal noise level that is added to the output signal to 50%.

[SOURce[1|2]]:PULSe:DCYClE

This command sets or queries the duty cycle of the pulse waveform for the specified channel. The setting range is 0.001% to 99.999% in increments of 0.001.

The arbitrary/function generator will hold the settings of leading edge and trailing edge when the duty cycle is varied.

Refer to the [SOURce[1|2]]:PULSe:WIDTh command for the setting range.

Group	Source
Related Commands	[SOURce[1 2]]:PULSe:WIDTh
Syntax	[SOURce[1 2]]:PULSe:DCYClE {<percent> MINimum MAXimum} [SOURce[1 2]]:PULSe:DCYClE? [MINimum MAXimum]
Arguments	<percent>::<<NR2>[<units>] where <NR2> is the duty cycle. <units>::=PCT
Returns	<percent>
Examples	SOURce1:PULSe:DCYClE 80.5 sets the duty cycle of the pulse waveform on CH 1 to 80.5%.

[SOURce[1|2]]:PULSe:DELay

This command sets or queries the lead delay of the pulse waveform for the specified channel.

Group	Source
Syntax	[SOURce[1 2]]:PULSe:DELay {<delay> MINimum MAXimum} [SOURce[1 2]]:PULSe:DELay? [MINimum MAXimum]
Arguments	<delay>::<<NR2>[<units>] where <NR2> is the lead delay. <units>::=[ns μ s ms s]

Setting range:

0 ns to Pulse Period (Continuous mode)

0 ns to Pulse Period – {Pulse Width + 0.8 × (Leading Edge Time + Trailing Edge Time)} (Triggered/Gated burst mode)

Returns <delay>

Examples SOURce1:PULSe:DELay 20ms
sets the CH 1 lead delay to 20 ms.

[SOURce[1|2]]:PULSe:HOLD

The [SOURce[1|2]]:PULSe:HOLD command sets the arbitrary/function generator to hold either pulse width or pulse duty.

The [SOURce[1|2]]:PULSe:HOLD? command returns WIDTH or DUTY.

Group Source

Syntax [SOURce[1|2]]:PULSe:HOLD {WIDTH|DUTY}

[SOURce[1|2]]:PULSe:HOLD?

Arguments WIDTH means that the arbitrary/function generator holds the pulse width setting.

DUTY means that the arbitrary/function generator holds the pulse duty setting.

Returns WIDT|DUTY

Examples SOURce1:PULSe:HOLD WIDTH
holds the CH 1 pulse width setting.

[SOURce[1|2]]:PULSe:PERiod

This command sets or queries the period for pulse waveform.

Group Source

Syntax [SOURce[1|2]]:PULSe:PERiod {<period>|MINimum|MAXimum}
[SOURce[1|2]]:PULSe:PERiod?[MINimum|MAXimum]

Arguments <period>::=<NRf>[<units>]
where
<NRf> is the pulse period.
<units>::=[ns | μ s | ms | s]

Returns <period>

Examples SOURce1:PULSe:PERiod 200ns
sets the CH 1 pulse period to 200 ns.

[SOURce[1|2]]:PULSe:TRANSition[:LEADing]

This command sets or queries the leading edge time of pulse waveform.

Group Source

Syntax [SOURce[1|2]]:PULSe:TRANSition[:LEADing] {<seconds>|MINimum|MAXimum}
[SOURce[1|2]]:PULSe:TRANSition[:LEADing]?[MINimum|MAXimum]

Arguments <seconds>::=<NRf>[<units>]
where
<NRf> is the leading edge time of pulse waveform.
<units>::=[ns | μ s | ms | s]

Returns <seconds>

Examples SOURce1:PULSe:TRANSition:LEADing 200ns
sets the CH 1 leading edge time to 200 ns.

[SOURce[1|2]]:PULSe:TRANSition:TRAIling

This command sets or queries the trailing edge time of pulse waveform.

Group Source

Syntax [SOURce[1|2]]:PULSe:TRANSition:TRAIling {<seconds>|MINimum|MAXimum}

[SOURce[1|2]]:PULSe:TRANSition:TRAIling?[MINimum|MAXimum]

Arguments <seconds>::=<NRf>[<units>]

where

<NRf> is the trailing edge of pulse waveform.

<units>::=[ns | μ s | ms | s]

Returns <seconds>

Examples SOURce1:PULSe:TRANSition:TRAIling 200ns
sets the trailing edge time to 200 ns.

[SOURce[1|2]]:PULSe:WIDTh

This command sets or queries the pulse width for the specified channel.

$$\text{Pulse Width} = \text{Period} \times \text{Duty Cycle} / 100$$

The pulse width must be less than the period. The setting range is 0.001% to 99.999% in terms of duty cycle.

AFG3011: 80 ns to 999.99 s

AFG3021B and AFG3022B: 30 ns to 999.99 s

AFG3101 and AFG3102: 8 ns to 999.99 s

AFG3251 and AFG3252: 4 ns to 999.99 s

$$\text{Pulse Width} \leq \text{Pulse Period} - 0.8 \times (\text{Leading Edge Time} + \text{Trailing Edge Time})$$

$$\text{Pulse Width} \geq 0.625 \times (\text{Leading Edge Time} + \text{Trailing Edge Time})$$

Group Source

Related Commands [SOURce[1|2]]:PULSe:DCYCl e

Syntax [SOURce[1|2]]:PULSe:WIDTh {<seconds>|MINimum|MAXimum}

[SOURce[1|2]]:PULSe:WIDTh?[MINimum|MAXimum]

Arguments <seconds>::=<NRf>[<units>]

where

<NRf> is the pulse width.

<units>::=[ns | μ s | ms | s]

Returns <seconds>

Examples SOURce1:PULSe:WIDTh 200ns
sets the CH 1 pulse width to 200 ns.

[SOURce[1|2]]:PWM:INTernal:FREQuency

This command sets or queries the internal modulation frequency of PWM modulation for the specified channel. You can use this command only when the internal modulation source is selected.

You can set the internal modulation frequency from 2 mHz to 50.00 kHz with resolution of 1 mHz.

You can select the source of modulating signal by using the [SOURce[1|2]]:PWM:SOURce [INTernal|EXTernal] command.

Group	Source
Related Commands	[SOURce[1 2]]:PWM:SOURce
Syntax	[SOURce[1 2]]:PWM:INTernal:FREQuency {<frequency> MINimum MAXimum} [SOURce[1 2]]:PWM:INTernal:FREQuency?[MINimum MAXimum]
Arguments	<frequency>::=<NRf>[<units>] where <NRf> is the modulation frequency. <units>::=[Hz kHz MHz]
Returns	<frequency>
Examples	SOURce1:PWM:INTernal:FREQuency 10kHz sets the CH 1 internal frequency to 10 kHz.

[SOURce[1|2]]:PWM:INTernal:FUNction

This command sets or queries the modulating waveform of PWM modulation for the specified channel. You can use this command only when the internal modulation source is selected.

If you specify EFILE when there is no EFILE or the EFILE is not yet defined, this command causes an error.

Group Source

Related Commands [SOURce[1|2]]:PWM:SOURce

Syntax [SOURce[1|2]]:PWM:INTernal:FUNction {SINusoid|SQUare|TRIangle|
RAMP|NRAMP|PRNoise|USER[1]|USER2|USER3|USER4|EMOMory|EFILE}

[SOURce[1|2]]:PWM:INTernal:FUNction?

Arguments SINusoid|SQUare|TRIangle|RAMP|NRAMP|PRNoise
One of six types of function waveform can be selected as a modulating signal.

USER[1]|USER2|USER3|USER4|EMEMory
A user defined waveform saved in the user waveform memory or the EMEMory can be selected as a modulating signal.

EFILE
EFILE is used as a modulating signal.

Returns SIN|SQU|TRI|RAMP|NRAMP|PRN|USER1|USER2|USER3|USER4|EMOMory|EFILE

Examples SOURce1:PWM:INTernal:FUNction SQUare
selects Square as the shape of modulating waveform for the CH 1 output.

[SOURce[1|2]]:PWM:INTernal:FUNction:EFILe

This command sets or queries an EFILe name used as a modulating waveform for PWM modulation. A file name must be specified in the mass storage system. This command returns “ ” if there is no file in the mass storage.

Group	Source
Syntax	[SOURce[1 2]]:PWM:INTernal:FUNction:EFILe <file_name> [SOURce[1 2]]:PWM:INTernal:FUNction:EFILe?
Arguments	<file_name>::=<string> specifies a file name in the mass storage system. The <file_name> includes path. Path separators are forward slashes (/).
Returns	<file_name>
Examples	SOURce1:PWM:INTernal:FUNction:EFILe “SAMPLE1” creates a file named “SAMPLE1” in the mass storage.

[SOURce[1|2]]:PWM:SOURce

This command sets or queries the source of modulating signal of PWM modulation for the specified channel.

Group	Source
Syntax	[SOURce[1 2]]:PWM:SOURce [INTernal EXTernal] [SOURce[1 2]]:PWM:SOURce?
Arguments	INTernal means that the carrier waveform is modulated with the internal source. EXTernal means that the carrier waveform is modulated with an external source.
Returns	INT EXT
Examples	SOURce1:PWM:SOURce INTernal sets the source of modulating signal on CH 1 to internal.

[SOURce[1|2]]:PWM:STATe

This command enables or disables PWM modulation. The query command returns the state of PWM modulation. You can select only pulse waveform as a carrier waveform for PWM.

Group Source

Syntax [SOURce[1|2]]:PWM:STATe {ON|OFF|<NR1>}
[SOURce[1|2]]:PWM:STATe?

Arguments ON or <NR1>≠0 enables PWM modulation.
OFF or <NR1>=0 disables PWM modulation.

Returns <NR1>

Examples SOURce1:PWM:STATe ON
enables the CH 1 PWM modulation.

[SOURce[1|2]]:PWM[:DEVIation]:DCYCLE

This command sets or queries the PWM deviation in percent for the specified channel.

The setting range must meet the following conditions:

$$\text{Deviation} \leq \text{Pulse Width} - \text{PWmin}$$

$$\text{Deviation} \leq \text{Pulse Period} - \text{Pulse Width} - \text{PWmin}$$

$$\text{Deviation} \leq \text{Pulse Width} - 0.8 \times (\text{Leading Edge Time} + \text{Trailing Edge Time})$$

$$\text{Deviation} \leq \text{Pulse Period} - \text{Pulse Width} - 0.8 \times (\text{Leading Edge Time} + \text{Trailing Edge Time})$$

where PWmin is the minimum pulse width.

Group	Source
Syntax	[SOURce[1 2]]:PWM[:DEVIation]:DCYCLE {<percent> MINimum MAXimum} [SOURce[1 2]]:PWM[:DEVIation]:DCYCLE? [MINimum MAXimum]
Arguments	<percent>::=<NR2>[<units>] where <NR2> is the PWM deviation. <units>::=PCT
Returns	<percent>
Examples	SOURce1:PWM[:DEVIation]:DCYCLE 5.0 sets the CH 1 PWM deviation to 5.0%.

[SOURce]:ROSCillator:SOURce

This command sets the reference clock to either internal or external.

Group Source

Syntax [SOURce]:ROSCillator:SOURce {INTernal|EXTernal}
[SOURce]:ROSCillator:SOURce?

Arguments INTernal means that the reference clock is set to internal.
EXTernal means that the reference clock is set to external.

Returns INT|EXT

Examples SOURce:ROSCillator:SOURce INTernal
selects the internal clock reference.

[SOURce[1|2]]:SWEep:HTIME

This command sets or queries the sweep hold time. Hold time represents the amount of time that the frequency must remain stable after reaching the stop frequency.

Group Source

Syntax [SOURce[1|2]]:SWEep:HTIME {<seconds>|MINimum|MAXimum}
[SOURce[1|2]]:SWEep:HTIME? [MINimum|MAXimum]

Arguments <seconds>::=<NRf>[<units>]
where
<NRf> is the hold time in seconds.
<units>::=[ns | μ s | ms | s]

Returns <seconds>

Examples SOURce1:SWEep:HTIME 1ms
sets the CH 1 hold time to 1 ms.

[SOURce[1|2]]:SWEep:MODE

The [SOURce[1|2]]:SWEep:MODE command selects auto or manual for the sweep mode for the specified channel.

The query command returns the sweep mode for the specified channel.

Group Source

Related Commands [SOURce[1|2]]:SWEep:HTIME
[SOURce[1|2]]:SWEep:RTIME
[SOURce[1|2]]:SWEep:TIME
TRIGger[:SEQuence]:SOURce
TRIGger[:SEQuence]:TIMER

Syntax [SOURce[1|2]]:SWEep:MODE {AUTO|MANua1}

[SOURce[1|2]]:SWEep:MODE?

Arguments AUTO sets the sweep mode to auto. The instrument outputs a continuous sweep at a rate specified by Sweep Time, Hold Time, and Return Time.

MANua1 sets the sweep mode to manual. The instrument outputs one sweep when a trigger input is received.

Returns AUTO|MAN

Examples SOURce1:SWEep:MODE AUTO
sets the CH1 sweep mode to auto. The instrument outputs a continuous sweep.

[SOURce[1|2]]:SWEep:RTIME

This command sets or queries the sweep return time. Return time represents the amount of time from stop frequency through start frequency. Return time does not include hold time.

Group Source

Syntax [SOURce[1|2]]:SWEep:RTIME {<seconds>|MINimum|MAXimum}

[SOURce[1|2]]:SWEep:RTIME? [MINimum|MAXimum]

Arguments <seconds>::=<NRf>[<units>]
where
<NRf> is the return time in seconds.
<units>::=[ns | μ s | ms | s]

Returns <seconds>

Examples SOURce1:SWEep:RTIME 1ms
sets the CH 1 return time to 1 ms.

[SOURce[1|2]]:SWEep:SPACing

The [SOURce[1|2]]:SWEep:SPACing command selects linear or logarithmic spacing for the sweep for the specified channel.

The query command returns the type for the sweep spacing for the specified channel.

Group Source

Syntax [SOURce[1|2]]:SWEep:SPACing {LINear|LOGarithmic}

[SOURce[1|2]]:SWEep:SPACing?

Arguments LINear sets the sweep spacing to linear.

LOGarithmic sets the sweep spacing to logarithmic.

Returns LIN|LOG

Examples SOURce1:SWEep:SPACing LINear
sets the CH1 sweep spacing to linear.

[SOURce[1|2]]:SWEep:TIME

This command sets or queries the sweep time for the sweep for the specified channel. The sweep time does not include hold time and return time. The setting range is 1 ms to 300 s.

Group Source

Syntax [SOURce[1|2]]:SWEep:TIME {<seconds>|MINimum|MAXimum}

[SOURce[1|2]]:SWEep:TIME? [MINimum|MAXimum]

Arguments <seconds>::=<NRf>[<units>]
where
<NRf> is the sweep time in seconds.
<units>::=[ns | μ s | ms | s]

Returns <seconds>

Examples SOURce1:SWEep:TIME 100ms
sets the CH 1 sweep time to 100 ms.

[SOURce[1|2]]:VOLTage:CONCurrent[:STATe]

This command enables or disables the function to copy the voltage level of one channel to another channel.

The [SOURce[1|2]]:VOLTage:CONCurrent[:STATe] command copies the voltage level of the channel specified by the header suffix to another channel. If you specify CH 1 with the header, the CH 1 voltage level will be copied to CH 2.

The query command returns “0” (off) or “1” (on).

If your arbitrary/function generator is a single-channel model, this command is not supported.

Group Source

Syntax [SOURce[1|2]]:VOLTage:CONCurrent[:STATe] {ON|OFF|<NR1>}

[SOURce[1|2]]:VOLTage:CONCurrent[:STATe]?

Arguments ON or <NR1>≠0 enables the concurrent copy function.

OFF or <NR1>=0 disables the concurrent copy function.

Returns <NR1>

Examples SOURce1:VOLTage:CONCurrent:STATe ON
enables the concurrent copy function.

[SOURce[1|2]]:VOLTage[:LEVel][:IMMediate]:HIGH

This command sets or queries the high level of output amplitude for the specified channel. If your instrument is a dual-channel model and the [SOURce[1|2]]:VOLTage:CONCurent[:STATE] command is set to ON, then the high level of other channel is also the same value.

Group Source

Related Commands [SOURce[1|2]]:VOLTage:CONCurent[:STATE]

Syntax [SOURce[1|2]]:VOLTage[:LEVel][:IMMediate]:HIGH {<voltage>|MINimum|MAXimum}

[SOURce[1|2]]:VOLTage[:LEVel][:IMMediate]:HIGH?[MINimum|MAXimum]

Arguments <voltage>::=<NRf>[<units>]
 where
 <NRf> is the high level of output amplitude.
 <units>::=[mV | V]

Returns <voltage>

Examples SOURce1:VOLTage:LEVel:IMMediate:HIGH 1V
 sets the high level of CH 1 output amplitude to 1 V.

[SOURce[1|2]]:VOLTage[:LEVel][:IMMediate]:LOW

This command sets or queries the low level of output amplitude for the specified channel. If your instrument is a dual-channel model and the [SOURce[1|2]]:VOLTage:CONCurent[:STATe] command is set to ON, then the low level of other channel is also the same value.

Group Source

Related Commands [SOURce[1|2]]:VOLTage:CONCurent[:STATe]

Syntax [SOURce[1|2]]:VOLTage[:LEVel][:IMMediate]:LOW {<voltage>|MINimum|MAXimum}

[SOURce[1|2]]:VOLTage[:LEVel][:IMMediate]:LOW? [MINimum|MAXimum]

Arguments <voltage>::=<NRf>[<units>]
where
<NRf> is the low level of output amplitude.
<units>::=[mV | V]

Returns <voltage>

Examples SOURce1:VOLTage:LEVel:IMMediate:LOW -1V
sets the low level of CH 1 output amplitude to -1 V.

[SOURce[1|2]]:VOLTage[:LEVel][:IMMediate]:OFFSet

This command sets or queries the offset level for the specified channel. If your instrument is a dual-channel model and the [SOURce[1|2]]:VOLTage:CONCurent[:STATE] command is set to ON, then the offset level of the other channel is also the same value.

Group Source

Related Commands [SOURce[1|2]]:VOLTage:CONCurent[:STATE]

Syntax [SOURce[1|2]]:VOLTage[:LEVel][:IMMediate]:OFFSet{<voltage>|MINimum|MAXimum}

[SOURce[1|2]]:VOLTage[:LEVel][:IMMediate]:OFFSet?[MINimum|MAXimum]

Arguments <voltage>::=<NRf>[<units>]
 where
 <NRf> is the offset voltage level.
 <units>::=[mV | V]

Returns <voltage>

Examples SOURce1:VOLTage:LEVel:IMMediate:OFFSet 500mV
 sets the CH 1 offset level to 500 mV.

[SOURce[1|2]]:VOLTage[:LEVel][:IMMediate][:AMPLitude]

This command sets or queries the output amplitude for the specified channel. If your instrument is two channel model and the [SOURce[1|2]]:VOLTage:CONCurent[:STATe] command is set to ON, then the output amplitude of the other channel is the same value.

Units	Amplitude resolution
VPP	0.1 mV _{p-p} or four digits
VRMS	0.1 mV _{rms} or four digits
DBM	0.1 dBm

You can set the units of output amplitude by using either the bezel menu selection or the [SOURce[1|2]]:VOLTage:UNIT command. The selection by bezel menu has priority over the remote command.

Group	Source
Related Commands	[SOURce[1 2]]:VOLTage:CONCurent[:STATe]
Syntax	[SOURce[1 2]]:VOLTage[:LEVel][:IMMediate][:AMPLitude] {<amplitude> MINimum MAXimum} [SOURce[1 2]]:VOLTage[:LEVel][:IMMediate][:AMPLitude]? [MINimum MAXimum]
Arguments	<amplitude>::=<NRf>[<units>] where <NRf> is the output amplitude. <units>::=[VPP VRMS DBM]
Returns	<amplitude>
Examples	SOURce1:VOLTage:LEVel:IMMediate:AMPLitude 1V sets the CH 1 output amplitude to 1 V.

[SOURce[1|2]]:VOLTage:LIMit:HIGH

This command sets or queries the higher limit of the output amplitude high level for the specified channel. If your instrument is a dual-channel model and the [SOURce[1|2]]:VOLTage:CONCurent[:STATE] command is set to ON, then the higher level limit of the other channel is the same value.

Group Source

Related Commands [SOURce[1|2]]:VOLTage:CONCurent[:STATE]

Syntax [SOURce[1|2]]:VOLTage:LIMit:HIGH {<voltage>|MINimum|MAXimum}
[SOURce[1|2]]:VOLTage:LIMit:HIGH? [MINimum|MAXimum]

Arguments <voltage>::=<NRf>[<units>]
where
<NRf> is the higher limit of output amplitude.
<units>::=[mV | V]

Returns <voltage>

Examples SOURce1:VOLTage:LIMit:HIGH 1V
sets the higher limit of CH 1 output amplitude to 1 V.

[SOURce[1|2]]:VOLTage:LIMit:LOW

This command sets or queries the lower limit of the output amplitude low level for the specified channel. If your instrument is a dual-channel model and the [SOURce[1|2]]:VOLTage:CONCurent[:STATe] command is set to ON, then the low level lower limit of the other channel is the same value.

Group Source

Related Commands [SOURce[1|2]]:VOLTage:CONCurent[:STATe]

Syntax [SOURce[1|2]]:VOLTage:LIMit:LOW {<voltage>|MINimum|MAXimum}
[SOURce[1|2]]:VOLTage:LIMit:LOW? [MINimum|MAXimum]

Arguments <voltage>::=<NRf>[<units>]
where
<NRf> is the lower limit of output amplitude.
<units>::=[mV | V]

Returns <voltage>

Examples SOURce1:VOLTage:LIMit:LOW 10mV
sets the lower limit of CH 1 output amplitude to 10 mV.

[SOURce[1|2]]:VOLTage:UNIT

This command sets or queries the units of output amplitude for the specified channel. This command does not affect the offset, High level, or Low level of output. The setting of this command is not affected by the units setting of [SOURce[1|2]]:VOLTage[:LEVe1][:IMMEDIATE][:AMPLitude] command.

$$V_{rms} = \frac{V_{pp}}{2\sqrt{2}} \text{ (sin)}$$

$$\text{dBm} = 10 \times \log_{10}\left(\frac{P}{0.001}\right) \quad P = \frac{V_{rms}^2}{R_L}$$

$$R_L \text{ load impedance } V_{rms} = \frac{V_{pp}}{2\sqrt{3}} \text{ (triangle)}$$

If your instrument is a dual-channel model and the [SOURce[1|2]]:VOLTage:CONCurent[:STATE] command is set to ON, then the units of the other channel are set the same.

Group	Source
Related Commands	[SOURce[1 2]]:VOLTage:CONCurent[:STATE] [SOURce[1 2]]:VOLTage[:LEVe1][:IMMEDIATE][:AMPLitude]
Syntax	[SOURce[1 2]]:VOLTage:UNIT {VPP VRMS DBM} [SOURce[1 2]]:VOLTage:UNIT?
Arguments	VPP sets the units of the output voltage to V_{p-p} . VRMS sets the units of the output voltage to V_{rms} . DBM sets the units of the output voltage to dBm. You cannot specify DBM if the load impedance is set to infinite.
Returns	VPP VRMS DBM
Examples	SOURce1:VOLTage:UNIT VPP sets the voltage units to V_{p-p} .

***SRE**

This command sets and queries the bits in the Service Request Enable Register (SRER).

Group Status

Related Commands *PSC

Syntax *SRE <bit_value>

*SRE?

Arguments <bit_value>::=<NR1>

where

<NR1> is a value in the range from 0 through 255. The binary bits of the SRER are set according to this value. Using an out-of-range value causes an execution error. The power-on default for SRER is 0 if *PSC is set to 1. If *PSC is set to 0, the SRER maintains the previous power cycle value through the current power cycle.

Returns <bit_value>

Examples *SRE 48
sets the bits in the SRER to binary 00110000.

*SRE?
might return 32, showing that the bits in the SRER have the binary value of 00100000.

STATus:OPERation:CONDition?

This query-only command returns the contents of the Operation Condition Register.

Group	Status
Syntax	STATus:OPERation:CONDition?
Arguments	None
Returns	<bit_value>::=<NR1>
Examples	STATus:OPERation:CONDition? might return 32 which indicates that the OCR contains the binary number 00000000 00100000 and the CH 1 of the instrument is waiting for trigger.

STATus:OPERation:ENABLE

This command sets or queries the mask for the Operation Enable Register.

Group	Status
Syntax	STATus:OPERation:ENABLE <bit_value> STATus:OPERation:ENABLE?
Arguments	<bit_value>::=<NR1>
Returns	<bit_value>
Examples	STATus:OPERation:ENABLE 1 sets the CALibrating bit in the OENR to on.

STATus:OPERation[:EVENT]?

This query-only command returns the value in the Operation Event Register and clears the Operation Event Register.

Group Status

Syntax STATus:OPERation[:EVENT]?

Arguments None

Returns <NR1>

Examples STATus:OPERation:EVENT?
might return 1 which indicates that the OEVR contains the binary number 00000000 00000001 and the CALibrating bit is set to on.

STATus:PRESet (No Query Form)

This command presets the SCPI status registers (OENR and QENR).

Group Status

Syntax STATus:PRESet

Arguments None

Examples STATus:PRESet
presets the SCPI status registers.

STATus:QUESTionable:CONDition?

This query-only command returns the contents of the Questionable Condition Register.

Group	Status
Syntax	STATus:QUESTionable:CONDition?
Arguments	None
Returns	<bit_value>::=<NR1>
Examples	STATus:QUESTionable:CONDition? might return 32 which indicates that the QCR contains the binary number 00000000 00100000 and the accuracy of frequency is questionable.

STATus:QUESTionable:ENABle

This command sets or queries the mask for the Questionable Enable Register.

Group	Status
Syntax	STATus:QUESTionable:ENABle <bit_value> STATus:QUESTionable:ENABle?
Arguments	<bit_value>::=<NR1>
Returns	<bit_value>
Examples	STATus:QUESTionable:ENABle 32 sets the FREQuency bit in the QENR to on.

STATus:QUESTionable[:EVENT]?

This query-only command returns the value in the Questionable Event Register and clears the Questionable Event Register.

Group	Status
Syntax	STATus:QUESTionable[:EVENT]?
Arguments	None
Returns	<bit_value>::=<NR1>
Examples	STATus:QUESTionable[:EVENT]? might return 32 which indicates that the QEVR contains the binary number 00000000 00100000 and the FREQUENCY bit is set to on.

***STB?**

This query-only command returns the contents of the Status Byte Register (SBR) using the Master Summary Status (MSS) bit.

Group	Status
Syntax	*STB?
Arguments	None
Returns	<NR1>
Examples	*STB? might return 96, showing that the SBR contains the binary value 01100000.

SYSTem:BEEPer[:IMMediate] (No Query Form)

This command causes the instrument to beep immediately.

Group	System
Syntax	SYSTem:BEEPer[:IMMediate]
Arguments	None
Examples	SYSTem:BEEPer:IMMediate causes a beep.

SYSTem:BEEPer:STATe

The SYSTem:BEEPer:STATe command sets the beeper ON or OFF.

The SYSTem:BEEPer:STATe? command returns “0” (OFF) or “1” (ON).

When the beeper is set to ON, the instrument will beep when an error message or a warning message is displayed on the screen. The instrument does not beep when an error or warning caused by remote command execution.

Group	System
Related Commands	SYSTem:BEEPer[:IMMediate]
Syntax	SYSTem:BEEPer:STATe {ON OFF <NR1>} SYSTem:BEEPer:STATe?
Arguments	ON or <NR1>≠0 enables the beeper. OFF or <NR1>=0 disables the beeper.
Returns	<NR1>
Examples	SYSTem:BEEPer:STATe ON enables the beeper function.

SYSTem:ERRor[:NEXT]?

This query-only command returns the contents of the Error/Event queue.

Group	System
Syntax	SYSTem:ERRor[:NEXT]?
Arguments	None
Returns	<Error/event number>::=<NR1> <Error/event description>::=<string>
Examples	SYSTem:ERRor:NEXT? might return the following response: -410,"Query INTERRUPTED"

If the instrument detects an error or an event occurs, the event number and event message will be returned.

SYSTem:KCLick[:STATe]

This command enables or disables the click sound when you push the front panel buttons or turn the general purpose knob. The query command returns "0" (OFF) or "1" (ON).

Group	System
Syntax	SYSTem:KCLick[:STATe] {ON OFF <NR1>} SYSTem:KCLick[:STATe]?
Arguments	ON or <NR1>≠0 enables click sound. OFF or <NR1>=0 disables click sound.
Returns	<NR1>
Examples	SYSTem:KCLick:STATe ON enables the click sound.

SYSTem:KLOCK[:STATe]

This command locks or unlocks the instrument front panel controls. The query command returns “0” (OFF) or “1” (ON).

Group	System
Syntax	SYSTem:KLOCK[:STATe] {ON OFF <NR1>} SYSTem:KLOCK[:STATe]?
Arguments	ON or <NR1>≠0 locks front panel controls. OFF or <NR1>=0 unlocks front panel controls.
Returns	<NR1>
Examples	SYSTem:KLOCK:STATe ON locks front panel controls.

SYSTem:PASSword:CDISable (No Query Form)

This command disables protected commands. The instrument security protection is activated.

In the AFG3000 Series Arbitrary/Function Generators, no remote commands are under the control of SYSTem:PASSword commands.

Group	System
Related Commands	SYSTem:PASSword[:CENable] SYSTem:PASSword[:CENable]:STATe? SYSTem:PASSword:NEW
Syntax	SYSTem:PASSword:CDISable <password>
Arguments	<password>::=<string> specifies current password. The string is case sensitive.
Examples	SYSTem:PASSword:CDISable <password> activates the security protection.

SYSTem:PASSword[:CENable] (No Query Form)

This command enables protected commands to function. The instrument security protection is deactivated.

In the AFG3000 Series Arbitrary/Function Generators, no remote commands are under the control of SYSTem:PASSword commands.

Group	System
Related Commands	SYSTem:PASSword:CDISable SYSTem:PASSword[:CENable]:STATE? SYSTem:PASSword:NEW
Syntax	SYSTem:PASSword[:CENable] <password>
Arguments	<password>::=<string> specifies current password. The string is case sensitive.
Examples	SYSTem:PASSword:CENable <password> deactivates the security protection.

SYSTem:PASSword[:CENable]:STATE?

This query-only command returns the security protection state.

Group	System
Related Commands	SYSTem:PASSword:CDISable SYSTem:PASSword[:CENable] SYSTem:PASSword:NEW
Syntax	SYSTem:PASSword[:CENable]:STATE?
Arguments	None
Returns	<NR1> where <NR1>=0 indicates that the security protection is in the on state. <NR1>≠0 indicates that the security protection is in the off state.
Examples	SYSTem:PASSword:CENable:STATE? might return 0, indicating that the instrument security protection is on.

SYSTem:PASSword:NEW (No Query Form)

This command changes the password.

Group	System
Related Commands	SYSTem:PASSword:CDISable SYSTem:PASSword[:CENable] SYSTem:PASSword[:CENable]:STATe?
Syntax	SYSTem:PASSword:NEW <current_password>,<new_password>
Arguments	<current_password>::=<string> specifies current password. <new_password>::=<string> specifies a new password. Password strings are case sensitive. A password must have at least four characters, and not more than 12 characters.
Examples	SYSTem:PASSword:NEW "DEFAULT","abc123" changes the current password DEFAULT to abc123.

SYSTem:SECurity:IMMEDIATE (No Query Form)

This command erases all the current instrument setups, setup memory, last setup memory, user waveform memory, and log content, and recalls the factory default settings. Calibration data is not erased.

The communication settings are initialized to the factory default settings. This might cause a remote communication error.

Group	System
Syntax	SYSTem:SECurity:IMMEDIATE
Arguments	None
Examples	SYSTem:SECurity:IMMEDIATE initializes the instrument.

SYSTem:ULANguage

This command sets or queries the language that the instrument uses to display information on the screen.

Group System

Syntax SYSTem:ULANguage {ENGLish|FRENch|GERMan|JAPanese|KOREan|SCHinese|TCHinese|RUSSian}

SYSTem:ULANguage?

Arguments ENGLish|FRENch|GERMan|JAPanese|KOREan|SCHinese|TCHinese|RUSSian specifies which language will be used to display instrument information on the screen.

Returns ENGLish|FRENch|GERMan|JAPanese|KOREan|SCHinese|TCHinese|RUSSian

Examples SYSTem:ULANguage FRENch specifies that the instrument displays information in French.

SYSTem:VERSion?

This query-only command returns the conformed SCPI version of the instrument.

Group System

Syntax SYSTem:VERSion?

Arguments None

Returns <SCPI Version>::=YYYY.V

where
YYYY — indicates year.
V — indicates the version number for that year.

Examples SYSTem:VERSion?
might return 1999.0.

TRACe|DATA:CATalog?

This query-only command returns the names of user waveform memory and edit memory.

Group	Trace
Syntax	TRACe DATA:CATalog?
Arguments	None
Returns	<string>
	A series of strings separated by commas is returned. Each string is enclosed within quotation marks.
Examples	DATA:CATalog? might return "USER1","USER4","EMEM"
	This example indicates that waveform data of USER2 and USER3 are deleted and not saved. Edit memory always has data.

TRACe|DATA:COPY (No Query Form)

This command copies the contents of edit memory (or user waveform memory) to a specified user waveform memory (or edit memory).

Group	Trace
Syntax	TRACe DATA:COPY <trace_name>,EMEMory TRACe DATA:COPY EMEMory,{USER[1] USER2 USER3 USER4}
Arguments	<trace_name>::={USER[1] USER2 USER3 USER4}
	This command is invalid when <trace_name> is being output.
Examples	DATA:COPY USER1,EMEMory copies the waveform data in the edit memory to the user waveform memory USER1.
	DATA:COPY EMEMory,USER1 copies the waveform data in the user waveform memory USER1 to the edit memory.

TRACe|DATA[:DATA]

This command transfers the waveform data from the external controller to the edit memory in the arbitrary/function generator. The query command returns the binary block data.

Group Trace

Syntax TRACe|DATA[:DATA] EMEMory,<binary_block_data>

TRACe|DATA[:DATA]? EMEMory

Arguments <binary_block_data>
where <binary_block_data> is the waveform data in binary format.

Returns <binary_block_data>

Examples DATA:DATA EMEMory,#42000<DAB><DAB>...<DAB>
transmits a waveform to the edit memory in the arbitrary/function generator. The block data element #42000 indicates that 4 is the number of digits in 2000 (byte count) and the 2000 bytes of binary data are to be transmitted.

TRACe|DATA[:DATA]:LINE (No Query Form)

This command writes line data to the edit memory. The data between the specified points is interpolated linearly.

Group Trace

Syntax TRACe|DATA[:DATA]:LINE EMEmory,<start_point>,<point_data1>,<end_point>,<point_data2>

Arguments <start_point>::=<NR1>
where <NR1> is the first point from which the data is interpolated linearly.

<point_data1>::=<NR1>
where <NR1> is the data value at the start point.

<end_point>::=<NR1>
where <NR1> is the last point from which the data is interpolated linearly.

<point_data2>::=<NR1>
where <NR1> is the data value at the end point.

Examples DATA:DATA:LINE EMEmory,1,2047,250,4094
sets a data value of 2047 for start point 1 and a data value of 4094 for end point 250, and interpolates linearly between these two points in the edit memory.

TRACe|DATA[:DATA]:VALue

This command sets or queries the data value at the specified point in the edit memory.

Group Trace

Syntax TRACe|DATA[:DATA]:VALue EMEORY,<point>,<data>

TRACe|DATA[:DATA]:VALue? EMEORY,<points>

Arguments <point>::=<NR1>
where <NR1> is the specified point number in the edit memory.

<data>::=<NR1>
where <NR1> is the data value for the specified point number.

Returns <NR1>

Examples DATA:DATA:VALue EMEORY,500,2047
sets the data value to 2047 for the point number 500 in the edit memory.

DATA:DATA:VALue? EMEORY,500
might return “2047”

This example indicates that the data value of point number 500 is set to 2047.

TRACe|DATA:DEFine (No Query Form)

This command resets the contents of edit memory.

Group Trace

Syntax TRACe|DATA:DEFine EMEemory[, {<points>|<trace_name>}]

Arguments <points>::=<NR1>
where <NR1> is the number of points for the waveform data in the edit memory that ranges from 2 to 131072.

If the second parameter in the argument is a numerical value, the length of the edit memory will be the number of points specified by this number and each point will be initialized to the default value (8191).

<trace_name>::={SINusoid|SQUare|PULSe|RAMP|NOISe}

If the second parameter in the argument is specified by <trace_name>, the specified waveform data will be copied to the edit memory. The number of points for the specified waveform data is equal to the number of points for one period of current waveform data in the edit memory.

If the <points> and <trace_name> parameters in the argument are omitted, the edit memory will be initialized to the default number of points (1000) and value (8191).

Examples DATA:DEFine EMEemory,1000
sets the length of the edit memory to 1000 points and resets the data points to the default value.

TRACe|DATA:DELeTe[:NAME] (No Query Form)

This command deletes the contents of specified user waveform memory.

Group Trace

Syntax TRACe|DATA:DELeTe <trace_name>

Arguments <trace_name>::={USER[1] | USER2 | USER3 | USER4}

This command is invalid when <trace_name> is being output, or <trace_name> is locked.

Examples DATA:DELeTe:NAME USER1
deletes the contents of USER1 waveform memory.

TRACe|DATA:LOCK[:STATe]

This command sets or queries whether to lock or unlock the user waveform memory.

Group Trace

Syntax TRACe|DATA:LOCK[:STATe] {USER[1] | USER2 | USER3 | USER4}, {ON | OFF | <NR1>}

TRACe|DATA:LOCK[:STATe]? {USER[1] | USER2 | USER3 | USER4}

Arguments ON or <NR1>≠0 locks the specified user waveform memory.

OFF or <NR1>=0 unlocks the specified user waveform memory.

Returns <NR1>

Examples DATA:LOCK:STATe USER1,ON
locks the USER1 waveform memory.

TRACe|DATA:POINts

This command sets or queries the number of data points for the waveform created in the edit memory.

Group Trace

Syntax TRACe|DATA:POINts EMEMory[,<points>|MINimum|MAXimum]

TRACe|DATA:POINts? EMEMory{,MIN|MAX}

Arguments <points>::=<NR1>
where <NR1> sets the number of points for the waveform created in the edit memory that ranges from 2 to 131072.

Returns <NR1>

Examples DATA:POINts EMEMory, 500
sets the waveform data points to 500 in the edit memory.

*TRG (No Query Form)

This command generates a trigger event.

Group Trigger

Related Commands TRIGger[:SEquence] [:IMMediate]

Syntax *TRG

Arguments None

Examples *TRG
generates a trigger event.

TRIGger[:SEQuence]:SLOPe

This command sets or queries the slope of trigger signal.

Group Trigger

Syntax TRIGger[:SEQuence]:SLOPe {POSitive|NEGative}

TRIGger[:SEQuence]:SLOPe?

Arguments POSitive indicates that the event occurs on the rising edge of the external trigger signal.

NEGative indicates that the event occurs on the falling edge of the external trigger signal.

Returns POS|NEG

Examples TRIGger:SEQuence:SLOPe POSitive
sets the trigger slope to positive, which triggers on the rising edge of the signal.

TRIGger[:SEQuence]:SOURce

This command sets or queries the trigger source for an external trigger signal.

Group Trigger

Syntax TRIGger[:SEQuence]:SOURce {TIMer|EXTernal}

TRIGger[:SEQuence]:SOURce?

Arguments TIMer specifies an internal clock as the trigger source.

EXTernal specifies an external trigger input as the trigger source.

Returns TIM|EXT

Examples TRIGger:SEQuence:SOURce EXTernal
sets an external trigger input as the trigger source.

TRIGger[:SEQuence]:TIMer

This command sets or queries the period of an internal clock when you select the internal clock as the trigger source with the TRIGger[:SEQuence]:SOURce command. The setting range is 1 μ s to 500.0 s.

Group Trigger

Related Commands TRIGger[:SEQuence]:SOURce

Syntax TRIGger[:SEQuence]:TIMer <seconds>
TRIGger[:SEQuence]:TIMer?

Arguments <seconds>::=<NRf>[<units>]
where
<units>::=[μ s | ms | s]

Returns <seconds>

Examples TRIGger:SEQuence:TIMer 5ms
sets the internal trigger rate to 5 ms.

TRIGger[:SEQuence][:IMMEDIATE] (No Query Form)

This command forces a trigger event to occur.

Group Trigger

Syntax TRIGger[:SEQuence][:IMMEDIATE]

Arguments None

Examples TRIGger:SEQuence:IMMEDIATE
generates a trigger event.

*TST?

This command performs a self-test and returns the results.

NOTE. *The self-test can take several minutes to complete. During this time, the arbitrary/function generator does not execute any commands. Do not power off the instrument during the self-test.*

Group	Calibration and Diagnostic
Related Commands	DIAGnostic[:ALL]?
Syntax	*TST?
Arguments	None
Returns	<NR1> where <NR1>=0 indicates that the self-test completed without errors. <NR1>≠0 indicates that the arbitrary/function generator detected an error.
Examples	*TST? performs a self-test and returns 0 if no error is reported.

*WAI (No Query Form)

This command prevents the instrument from executing further commands or queries until all pending commands that generate an OPC message are complete.

Group	Synchronization
Related Commands	*OPC
Syntax	*WAI
Arguments	None
Examples	*WAI prevents the instrument from executing any further commands or queries until all pending commands that generate an OPC message are complete.



Status and Events

Status and Events

This section provides details about the status information and events the arbitrary/function generator reports.

Status Reporting Structure

The arbitrary/function generator status reporting functions conform to IEEE-488.2 and SCPI standards. Use the status reporting function to check for instrument errors and to identify the types of events that have occurred on the instrument.

Figure 3-1 shows an outline of the instrument error and event reporting function.

The error and event reporting system consists of the following three blocks:

- Standard/Event Status
- Operation Status
- Questionable Status

The operations processed in these blocks are summarized in status bytes, which provide the error and event data.

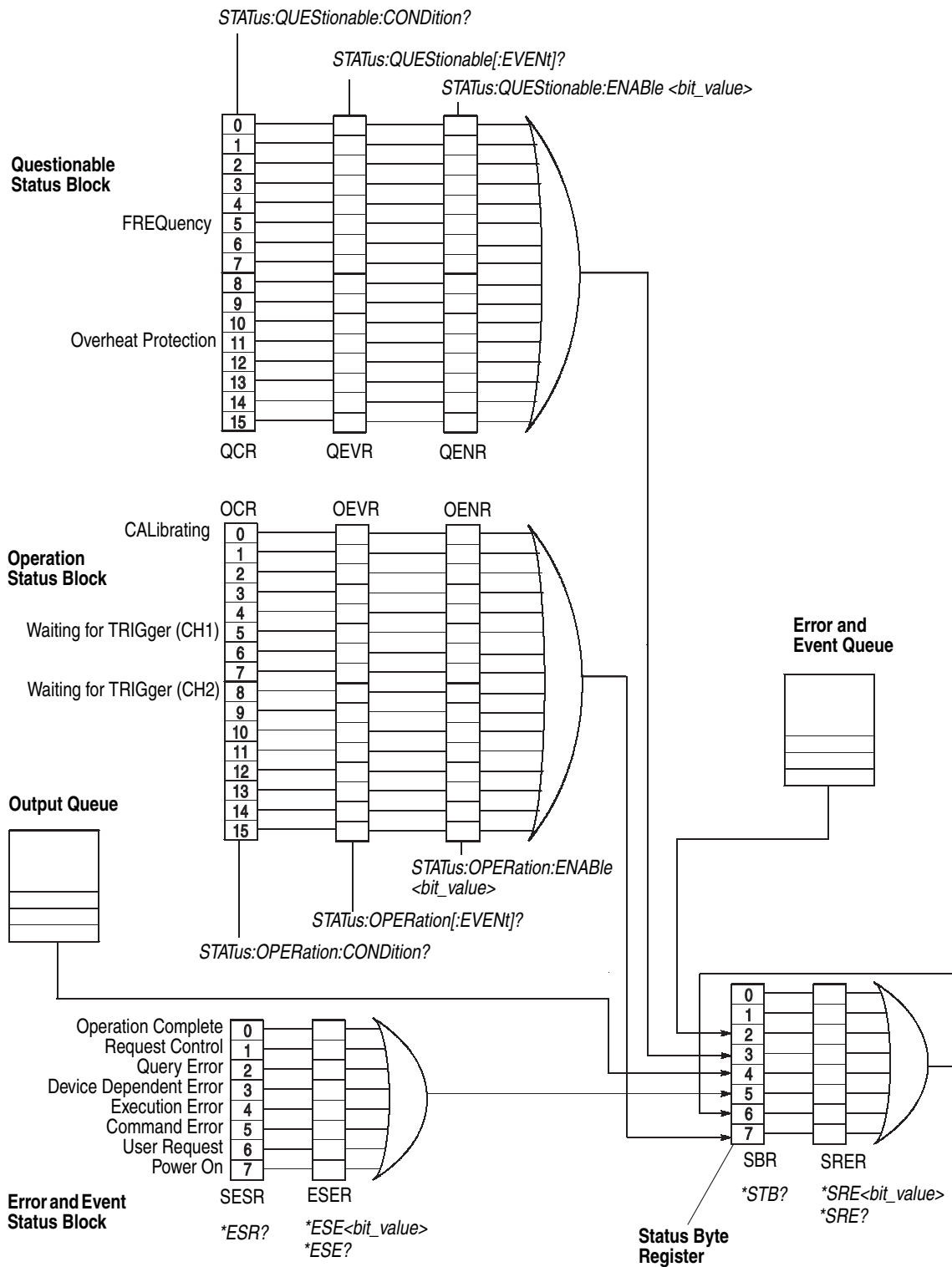

Figure 3-1: Error and event handling process

Standard/Event Status Block This block is used to report power on/off, command error, and command execution status.

The block has two registers: the Standard Event Status Register (SESR) and the Event Status Enable Register (ESER). Refer to the Standard/Event Status Block shown at the bottom of Figure 3-1.

Standard Event Status Register. The SESR is an eight-bit status register. When an error or other type of event occurs on the instrument, the corresponding bit is set. You cannot write to this register.

Event Status Enable Register. The ESER is an eight-bit enable register that masks the SESR. You can set this mask, and take AND with the SESR to determine whether or not the ESB bit in the Status Byte Register (SBR) should be set.

Operation Status Block This block is used to report on the status of several operations being executed by the arbitrary/function generator.

The block has three registers: the Operation Condition Register (OCR), the Operation Event Register (OEVR), and the Operation Enable Register (OENR). Refer to the Operation Status Block shown in Figure 3-1.

Operation Condition Register. When the instrument achieves a certain status, the corresponding bit is set to the OCR. It is not allowed for the user to write to this register.

Operation Event Register. The OCR bits that have changed from false (reset) to true (set) status are set in the OEVR.

Operation Enable Register. The function of the OENR is to mask the OEVR. You can set this mask and take AND with the OEVR to determine whether or not the OSS bit in the Status Byte Register (SBR) should be set.

Questionable Status Block This block reports on the status of signals and data, such as the accuracy of entered data and signals generated by the instrument. The register configuration and process flow are the same as the Questionable Status Block.

Registers

The registers in the event reporting system fall into two functional groups:

- The Status Registers contain information about the status of the instrument.
- Enable Registers determine whether selected types of events are reported to the Status Registers and the Event Queue.

Status Registers

There are six types of status registers:

- Status Byte Register (SBR), page 3-5
- Standard Event Status Register (SESR), page 3-6
- Operation Condition Register (OCR), page 3-7
- Operation Event Register (OEVR), page 3-7
- Questionable Condition Register (QCR), page 3-8
- Questionable Event Register (QEVR), page 3-8

Status Byte Register (SBR). The SBR is made up of 8 bits. Bits 4, 5 and 6 are defined in accordance with IEEE Std 488.2-1992 (see Figure 3-2). These bits are used to monitor the output queue, SESR, and service requests, respectively.

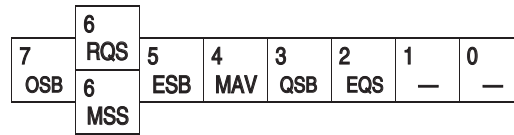

Figure 3-2: The Status Byte Register (SBR)

Table 3-1: SBR bit functions

Bit	Function	
7 (MSB)	OSB	Operation Status Bit. Indicates that an operation event has occurred.
6	RQS	Request Service. When the instrument is accessed using the GPIB serial poll command, this bit is called the Request Service (RQS) bit and indicates to the controller that a service request has occurred (in other words, that the GPIB bus SRQ line is LOW). The RQS bit is cleared when serial poll ends.
6	MSS	Master Status Summary. When the instrument is accessed using the *STB? query, this bit is called the Master Status Summary (MSS) bit and indicates that the instrument has issued a service request for one or more reasons. The MSS bit is never cleared to 0 by the *STB? query.
5	ESB	Event Status Bit. This bit indicates whether or not a new event has occurred after the previous Standard Event Status Register (SESR) has been cleared or after an event readout has been performed.
4	MAV	Message Available Bit. This bit indicates that a message has been placed in the output queue and can be retrieved.
3	QSB	Questionable Status Bit.
2	EQS	Error/Event Queue Summary.
1-0	—	Not used

Standard Event Status Register (SESR). The SESR records eight types of events that can occur within the instrument as shown in Figure 3-3.

7	6	5	4	3	2	1	0
PON	URQ	CME	EXE	DDE	QYE	RQC	OPC

Figure 3-3: The Standard Event Status Register (SESR)

Table 3-2: SESR bit functions

Bit	Function
7 (MSB)	PON Power On. Indicates that the power to the instrument is on.
6	URQ User Request. Indicates that an application event has occurred. The arbitrary/function generator does not use this bit.
5	CME Command Error. Indicates that an error occurred while the arbitrary/function generator was parsing a command or query.
4	EXE Execution Error. Indicates that an error occurred while the arbitrary/function generator was executing a command or query. Execution errors occur for one of the following reasons: <ul style="list-style-type: none"> ■ A value designated in the argument is outside the allowable range of the instrument, or is in conflict with the capabilities of the instrument. ■ The command was not executed properly because the conditions for execution is differed from those required.
3	DDE Device Error. An instrument error has been detected.
2	QYE Query Error. Indicates that a query error has been detected by the output queue controller. Query errors occur for one of the following reasons: <ul style="list-style-type: none"> ■ An attempt was made to retrieve messages from the output queue when the output queue is empty or in pending status. ■ The output queue message was cleared while it was being retrieved from the output queue.
1	RQC Request Control. The arbitrary/function generator does not use this bit.
0	OPC Operation Complete. Indicates that the operation is complete. This bit is set when all pending operations complete following the *OPC command.

Operation Event Register (OEVR). This register has the same content as the Operation Condition Register.

Operation Condition Register (OCR). The Operation Condition Register is made up of sixteen bits, which note the occurrence of events as shown in Figure 3-4.

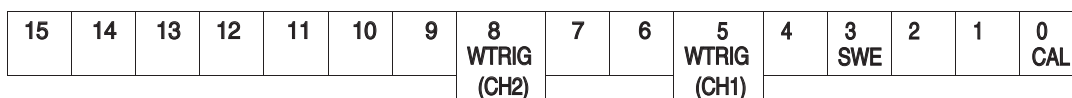

Figure 3-4: Operation Condition Register (OCR)

Table 3-3: OCR bit functions

Bit	Function
15 to 9	—— Not used
8	WTRIG CH2 Waiting for Trigger. Indicates whether the instrument is waiting for a trigger. This bit is set when CH 2 (in the case of dual-channel model) is waiting for a trigger. Bit is reset when the waiting-for-trigger status is canceled.
5	WTRIG CH1 Waiting for Trigger. Indicates whether the instrument is waiting for a trigger. This bit is set when CH 1 (in the case of dual-channel model) is waiting for a trigger. Bit is reset when the waiting-for-trigger status is canceled.
4	—— Not used
3	SWE Sweep. Indicates whether the instrument is executing a frequency sweep. This bit is set when a frequency sweep is being executed on CH 1 or another channel (in the case of dual-channel model). Bit is reset when the execution stops.
2 to 1	—— Not used
0	CAL Calibration. Indicates whether the instrument is being calibrated. This bit is set when calibration is in progress and is reset when the calibration is complete.

Questionable Event Register (QEVR). This register has the same content as the Questionable Condition Register.

Questionable Condition Register (QCR). The Questionable Condition Register is made up of sixteen bits which note the occurrence of two types of events.

15	14	13	12	11 OVHP	10	9	8	7	6	5 FREQ	4	3	2	1	0
----	----	----	----	------------	----	---	---	---	---	-----------	---	---	---	---	---

Figure 3-5: Questionable Condition Register (QCR)

Table 3-4: QCR bit functions

Bit	Function
15 to 12	—— Not used
11	OVHP Overheat protection. Indicates whether the instrument internal temperature is in questionable condition.
10 to 6	—— Not used
5	FREQ Frequency. Indicates whether frequency accuracy of the signal is of questionable quality.
4 to 0	—— Not used

Enable Registers

There are four types of enable registers:

- Event Status Enable Register (ESER), page 3-8
- Service Request Enable Register (SRER), page 3-9
- Operation Enable Register (OENR), page 3-9
- Questionable Enable Register (QENR), page 3-10

Each bit in the enable registers corresponds to a bit in the controlling status register. By setting and resetting the bits in the enable register, you can determine whether or not events that occur will be registered to the status register and queue.

Event Status Enable Register (ESER). The ESER consists of bits defined exactly the same as bits 0 through 7 in the SESR register. You can use this register to control whether or not the Event Status Bit (ESB) in the SBR should be set when an event has occurred, and to determine if the corresponding SESR bit is set.

To set the ESB in the SBR (when the SESR bit has been set), set the ESER bit corresponding to that event. To prevent the ESB from being set, reset the ESER bit corresponding to that event.

Use the *ESC command to set the bits in the ESER. Use the *ESR? query to read the contents of the ESER. Figure 3-6 shows the ESER functions.

7	6	5	4	3	2	1	0
PON	URQ	CME	EXE	DDE	QYE	RQC	OPC

Figure 3-6: Event Status Enable Register (ESER)

Service Request Enable Register (SRER). The SRER consists of bits defined exactly the same as bits 0 through 7 in the SBR. You can use this register to define which events will generate service requests.

The SRER bit 6 cannot be set. Also, the RQS is not maskable.

The generation of a service request with the GPIB interface involves changing the SRQ line to LOW, and making a service request to the controller. The result is that a status byte for which an RQS has been set is returned in response to serial polling by the controller.

Use the *SRE command to set the bits of the SRER. Use the *SRE? query to read the contents of the SRER. Bit 6 must be set to 0. Figure 3-7 shows the SRER functions.

	6						
	RQS	5	4	3	2	1	0
7		ESB	MAV	QSB	EQS	—	—
	6						
	MSS						

Figure 3-7: Service Request Enable Register (SRER)

Operation Enable Register (OENR). The OENR consists of bits defined exactly the same as bits 0 through 15 in the OEVR (see Figure 3-8). You can use this register to control whether or not the Operation Status Bit (OSB) in the SBR is set when an event occurs and the corresponding OEVR bit is set.

Use the STATus:OPERation:ENABLE command to set the bits in the OENR. Use the STATus:OPERation:ENABLE? query to read the contents of the OENR.

15	14	13	12	11	10	9	8	7	6	5	4	3	2	1	0
							WTRIG (CH2)			WTRIG (CH1)		SWE			CAL

Figure 3-8: Operation Enable Register (OENR)

Questionable Enable Register (QENR). The QENR consists of bits defined exactly the same as bits 0 through 15 in the QEVR register (see Figure 3-9). You can use this register to control whether the QSB in the SBR is set when an event occurs and the corresponding QEVR bit is set.

Use the `STATus:QUESTionable:ENABle` command to set the bits in the QENR. Use the `STATus:QUESTionable:ENABle?` query to read the contents of the QENR.

15	14	13	12	11 OVHP	10	9	8	7	6	5 FREQ	4	3	2	1	0
----	----	----	----	------------	----	---	---	---	---	-----------	---	---	---	---	---

Figure 3-9: Questionable Enable Register (QENR)

Queues

There are two types of queues in the status reporting system: output queue and error/event queues.

Output Queue

The output queue is an FIFO (first-in, first-out) queue that holds response messages to queries awaiting retrieval. When there are messages in the queue, the MAV bit in the SBR is set.

The output queue is emptied each time a command or query is received, so the controller must read the output queue before the next command or query is issued. If this is not done, an error occurs and the output queue is emptied; however, the operation proceeds even if an error occurs.

Error/Event Queue

The event queue is an FIFO queue, which stores events as they occur in the instrument. If more than 64 events are stored, the 64th event is replaced with event code -350 (“Queue Overflow”).

The oldest error code and text are retrieved by using one of the following queries:

```
SYSTem:ERRor[:NEXT]?
```

First, issue the `*ESR?` query to read the contents of the SESR. The contents of the SESR are cleared after they are read. If an SESR bit is set, events are stacked in the Error/Event Queue. Retrieve the event code with the following command sequence:

```
*ESR?
```

```
SYSTem:ERRor[:NEXT]?
```

If you omit the `*ESR?` query, the SESR bit will remain set, even if the event disappears from the Error/Event Queue.

Messages and Codes

Error and event codes with negative values are SCPI standard codes. Error and event codes with positive values are unique to the AFG3000 Series Arbitrary/Function Generators.

Table 3-5 lists event code definitions. When an error occurs, you can find its error class by checking for the code range in Table 3-6 through Table 3-14. Events in these tables are organized by event class.

Table 3-5: Definition of event codes

Event class	Code range	Description
No error	0	No event or status
Command errors	-100 to -199	Command syntax errors
Execution errors	-200 to -299	Command execution errors
Device-specific errors	-300 to -399	Internal device errors
Query errors	-400 to -499	System event and query errors
Power-on events	-500 to -599	Power-on events
User request events	-600 to -699	User request events
Request control events	-700 to -799	Request control events
Operation complete events	-800 to -899	Operation complete events
Extended device-specific errors	1 to 32767	Device dependent device errors
Reserved	other than above	not used

Command Errors

Table 3-6 shows the error messages generated by improper command syntax. Check that the command is properly formed and that it follows the rules in the *Syntax and Commands* starting on page 2-1.

Table 3-6: Command error messages

Error code	Error message
-100	Command error
-101	Invalid character
-102	Syntax error
-103	Invalid separator
-104	Data type error
-105	GET not allowed
-108	Parameter not allowed
-109	Missing parameter
-110	Command header error
-111	Header separator error
-112	Program mnemonic too long

Table 3-6: Command error messages (cont.)

Error code	Error message
-113	Undefined header
-114	Header suffix out of range
-115	Unexpected number of parameters
-120	Numeric data error
-121	Invalid character in number
-123	Exponent too large
-124	Too many digits
-128	Numeric data not allowed
-130	Suffix error
-131	Invalid suffix
-134	Suffix too long
-138	Suffix not allowed
-140	Character data error
-141	Invalid character data
-144	Character data too long
-148	Character data not allowed
-150	String data error
-151	Invalid string data
-158	String data not allowed
-160	Block data error
-161	Invalid block data
-168	Block data not allowed
-170	Expression error
-171	Invalid expression
-178	Expression data not allowed
-180	Macro error
-181	Invalid outside macro definition
-183	Invalid inside macro definition
-184	Macro parameter error

Execution Errors Table 3-7 lists the errors that are detected during execution of a command.

Table 3-7: Execution error messages

Error code	Error message
-200	Execution error
-201	Invalid while in local
-202	Settings lost due to RTL
-203	Command protected
-210	Trigger error
-211	Trigger ignored
-212	Arm ignored
-213	Init ignored
-214	Trigger deadlock
-215	Arm deadlock
-220	Parameter error
-221	Settings conflict
-222	Data out of range
-223	Too much data
-224	Illegal parameter value
-225	Out of memory
-226	Lists not same length
-230	Data corrupt or stale
-231	Data questionable
-232	Invalid format
-233	Invalid version
-240	Hardware error
-241	Hardware missing
-250	Mass storage error
-251	Missing mass storage
-252	Missing media
-253	Corrupt media
-254	Media full
-255	Directory full
-256	File name not found
-257	File name error
-258	Media protected
-260	Expression error
-261	Math error in expression
-270	Macro error
-271	Macro syntax error
-272	Macro execution error
-273	Illegal macro label

Table 3-7: Execution error messages (cont.)

Error code	Error message
-274	Macro parameter error
-275	Macro definition too long
-276	Macro recursion error
-277	Macro redefinition not allowed
-278	Macro header not found
-280	Program error
-281	Cannot create program
-282	Illegal program name
-283	Illegal variable name
-284	Program currently running
-285	Program syntax error
-286	Program runtime error
-290	Memory use error
-291	Out of memory
-292	Referenced name does not exist
-293	Referenced name already exists
-294	Incompatible type

Device Specific Errors

Table 3-8 lists the device-specific errors that can occur during arbitrary/function generator operation. These errors may indicate that the instrument needs repair.

Table 3-8: Device-specific error messages

Error code	Message
-300	Device specific error
-310	System error
-311	Memory error
-312	PUD memory lost
-313	Calibration memory lost
-314	Save/recall memory lost
-315	Configuration memory lost
-320	Storage fault
-321	Out of memory
-330	Self-test failed
-340	Calibration failed
-350	Queue overflow
-360	Communication error
-361	Parity error in program message
-362	Framing error in program message
-363	Input buffer overrun
-365	Time out error

Query Errors

Table 3-9 lists the error codes that are returned in response to an unanswered query.

Table 3-9: Query errors

Error codes	Message
-400	query error
-410	query INTERRUPTED
-420	query UNTERMINATED
-430	query DEADLOCKED
-440	query UNTERMINATED after indefinite response

Power-on Events

These events occur when the instrument detects an off to on transition in its power supply.

Table 3-10: Power-on events

Event code	Event message
-500	Power on

User Request Events These events are not used in this instrument.

Table 3-11: User request events

Event code	Event message
-600	User request

Request Control Events These events are not used in this instrument.

Table 3-12: Request control events

Event code	Event message
-700	Request control

Operation Complete Events These events occur when instrument’s synchronization protocol, having been enabled by an *OPC command, completes all selected pending operations.

Table 3-13: Operation complete events

Event code	Event message
-800	Operation complete

Device Errors Table 3-14 lists the error codes that are unique to the AFG3000 Series Arbitrary/Function Generators.

Table 3-14: Device errors

Error code	Error message
1101	Calibration failed; CH1 Internal offset
1102	Calibration failed; CH2 Internal offset
1103	Calibration failed; CH1 Output offset
1104	Calibration failed; CH2 Output offset
1105	Calibration failed; CH1 Output gain
1106	Calibration failed; CH2 Output gain
1201	Calibration failed; CH1 x 3 dB attenuator
1202	Calibration failed; CH2 x 3 dB attenuator
1203	Calibration failed; CH1 x 6 dB attenuator
1204	Calibration failed; CH2 x 6 dB attenuator
1205	Calibration failed; CH1 x 10 dB attenuator
1206	Calibration failed; CH2 x 10 dB attenuator
1207	Calibration failed; CH1 x 20 dB 1 attenuator
1208	Calibration failed; CH2 x 20 dB 1 attenuator
1209	Calibration failed; CH1 x 20 dB 2 attenuator
1210	Calibration failed; CH2 x 20 dB 2 attenuator
1211	Calibration failed; CH1 Filter
1212	Calibration failed; CH2 Filter
1213	Calibration failed; CH1 x 20 dB 3 attenuator
1301	Calibration failed; CH1 Sine Flatness
1302	Calibration failed; CH2 Sine Flatness
1401	Calibration failed; CH1 ASIC TINT
1402	Calibration failed; CH2 ASIC TINT
1403	Calibration failed; CH1 ASIC SGEN
1404	Calibration failed; CH2 ASIC SGEN
1405	Calibration failed; CH1 ASIC clock duty
1406	Calibration failed; CH2 ASIC clock duty
2100	Self-test failed; Calibration data not found
2101	Self-test failed; Calibration data checksum
2102	Self-test failed; Calibration data invalid
2201	Self-test failed; ASIC 1 memory
2202	Self-test failed; ASIC 2 memory
2203	Self-test failed; ASIC 1 overheat
2204	Self-test failed; ASIC 2 overheat
2301	Self-test failed; CH1 Internal offset
2302	Self-test failed; CH2 Internal offset
2303	Self-test failed; CH1 Output offset

Table 3-14: Device errors (cont.)

Error code	Error message
2304	Self-test failed; CH2 Output offset
2305	Self-test failed; CH1 Output gain
2306	Self-test failed; CH2 Output gain
2401	Self-test failed; CH1 x 3 dB attenuator
2402	Self-test failed; CH2 x 3 dB attenuator
2403	Self-test failed; CH1 x 6 dB attenuator
2404	Self-test failed; CH2 x 6 dB attenuator
2405	Self-test failed; CH1 x 10 dB attenuator
2406	Self-test failed; CH2 x 10 dB attenuator
2407	Self-test failed; CH1 x 20 dB 1 attenuator
2408	Self-test failed; CH2 x 20 dB 1 attenuator
2409	Self-test failed; CH1 x 20 dB 2 attenuator
2410	Self-test failed; CH2 x 20 dB 2 attenuator
2411	Self-test failed; CH1 Filter
2412	Self-test failed; CH2 Filter
2413	Self-test failed; CH1 x 20 dB 3 attenuator
2501	Self-test failed; CH1 Sine Flatness
2502	Self-test failed; CH2 Sine Flatness
9112	Waveform error; invalid waveform length
9113	Waveform error; waveform length is too short



Programming Examples

Programming Examples

The following two example programs, which demonstrate methods that you can use to control the arbitrary/function generator through the General Purpose Interface Bus (GPIB), are included on the *AFG3000 Series Arbitrary/Function Generators Product CD*.

- Example 1: Set up a Waveform Output
- Example 2: Waveform Transfer and Copy

The example programs are written in Microsoft Visual Basic Version 6.0. The programs run on Windows PC compatible systems equipped with TekVISA and a National Instruments GPIB board with the associated drivers.

TekVISA is the Tektronix implementation of the VISA Application Programming Interface (API). TekVISA is industry-compliant software for writing interoperable instrument drivers in a variety of Application Development Environments (ADEs).

The example programs assume that the GPIB system recognizes the PC (external controller) as GPIB0, and the address number of the instrument as 11.

If you use an interface other than GPIB, change the resource name of source code. Refer to TekVISA manual for details about resource.

Example 1 This is a sample program for setting the arbitrary/function generator outputs.

```

Private Sub Sample1_Click()
/
'Assign resource
/
Tvc1.Descriptor = "GPIB0::11::INSTR"
/
'Initialize of device setting
/
Tvc1.WriteString ("*RST")
/
'Set CH1 output parameters
/
Tvc1.WriteString ("FUNCTION SIN") 'Set output waveform SIN
Tvc1.WriteString ("FREQUENCY 10E3") 'Set frequency 10kHz
Tvc1.WriteString ("VOLTAGE:AMPLITUDE 2.00") 'Set amplitude 2Vpp
Tvc1.WriteString ("VOLTAGE:OFFSET 1.00") 'Set offset 1V
Tvc1.WriteString ("PHASE:ADJUST 0DEG") 'Set phase 0degree
/
'Set CH2 output parameters
/
Tvc1.WriteString ("SOURCE2:FUNCTION SIN") 'Set output waveform SIN
Tvc1.WriteString ("SOURCE2:FREQUENCY 10E3") 'Set frequency 10kHz
Tvc1.WriteString ("SOURCE2:VOLTAGE:AMPLITUDE 1.00") 'Set amplitude 1Vpp
Tvc1.WriteString ("SOURCE2:VOLTAGE:OFFSET 0.00") 'Set offset 0V
Tvc1.WriteString ("SOURCE2:PHASE:ADJUST 90DEG") 'Set phase 90degrees
/
'Save settings and output on
/
Tvc1.WriteString ("*SAV 1") 'Save settings to Setup1
Tvc1.WriteString ("*RCL 1") 'Recall settings from Setup1

End Sub

```

Example 2 This is a sample program for sending an arbitrary waveform to the arbitrary/function generator's Edit Memory and copying the contents of Edit Memory to the user waveform memory.

```

Private Sub Sample2_Click()
'
'Assign resource
'
Tvc1.Descriptor = "GPIB0::11::INSTR"

'Initialize of device setting
'
Tvc1.WriteString ("*RST")

'Make arbitrary block data (2000 Points)
'
Dim wave(4000) As Byte

For i = 0 To 499 'Leading edge (500 Points)
    Data = i * Int(16382 / 500) 'Data range is from 0 to 16382
    High = Int(Data / 256) 'AFG's Data Format is big endian
    Low = Data - (High * 256)

    wave(2 * i) = High
    wave(2 * i + 1) = Low
Next i

For i = 500 To 799 'Part of High Level (800 Points)
    Data = 16382
    High = Int(Data / 256)
    Low = Data - (High * 256)

    wave(2 * i) = High
    wave(2 * i + 1) = Low
Next i

For i = 800 To 999 'Trailing Edge (200 Points)
    Data = (1000 - i) * Int(16382 / 200)
    High = Int(Data / 256)
    Low = Data - (High * 256)

    wave(2 * i) = High
    wave(2 * i + 1) = Low

```

```
Next i

For i = 1000 To 1999 'Part of Low Level (1000 Points)
  Data = 0
  High = Int(Data / 256)
  Low = Data - (High * 256)

  wave(2 * i) = High
  wave(2 * i + 1) = Low
Next i

/
'Transfer waveform
' Transfer arbitrary block data to edit memory
/
Tvc1.SendEndEnabled = False
Tvc1.WriteString ("TRACE:DATA EMEMORY,#44000")

Tvc1.SendEndEnabled = True
Tvc1.WriteByteArray (wave)
/
'Copy contents of edit memory to USER1
/
Tvc1.WriteString ("TRAC:COPY USER1,EMEM")

/
'Set CH1 output parameters
/
Tvc1.WriteString ("FUNCTION USER1") 'Set output waveform USER1
Tvc1.WriteString ("FREQUENCY 8K") 'Set frequency 8kHz
Tvc1.WriteString ("OUTPUT ON") 'Set CH1 output on

End Sub
```



Appendices

Appendix A: Accessories and Options

This section lists the standard and optional accessories available for the instrument, as well as the product options.

Options

The following options can be ordered for the instrument:

Table A-1: Options

Option	Description
Power cord options	
Option A0	North America
Option A1	Universal Euro
Option A2	United Kingdom
Option A3	Australia
Option A5	Switzerland
Option A6	Japan
Option A10	China
Option A99	No power cord or AC adapter
Manual options	
Option L0	English Manual
Option L1	French Manual
Option L2	Italian Manual
Option L3	German Manual
Option L4	Spanish Manual
Option L5	Japanese Manual
Option L7	Simplified Chinese Manual
Option L8	Traditional Chinese Manual
Option L9	Korean Manual
Option L10	Russian Manual
Option L99	No printed Manual
Service options	
Option C3	Calibration Service 3 Years
Option C5	Calibration Service 5 Years
Option D1	Calibration Data Report
Option D3	Calibration Data Report 3 Years (with Option C3)
Option D5	Calibration Data Report 5 Years (with Option C5)
Option R5	Repair Service 5 Years

Accessories

All accessories (standard and optional) are available by contacting your local Tektronix field office. Table A-2 lists standard accessories for this instrument.

Standard The following accessories are shipped with the instrument:

Table A-2: Standard accessories

Accessory	Part number
AFG3000 Series Quick Start User Manual A single printed manual is included. Refer to Table A-3 for a complete list of available language manuals.	—
AFG3000 Series Document CD	063-3828-xx
ArbExpress Software CD	063-3763-xx
Power Cord	—

The AFG3000 Series Document CD contains the following items:

- Quick Start User Manuals (10 languages, PDF)
- Programmer Manual (this document, PDF)
- LabVIEW Plug and Play and IVI-C drivers

The LabVIEW Plug and Play driver provides connectivity to National Instrument's LabVIEW application. It requires LabVIEW and NI-VISA. Programming examples are included. Consult the readme document inside the zipped LabVIEW driver file for installation instructions. The IVI-C driver provides standard communication and command structure for communication with higher level applications. It requires IVI Compliance Package and NI-VISA. NI-VISA and other needed utilities can be downloaded from National Instrument Web site:

<http://www.ni.com>

Optional The accessories in Table A-3 are orderable for use with the instrument at the time this manual was originally published. Check the Tektronix Web site (www.tektronix.com) for the most current information.

Table A-3: Optional accessories

Accessory	Part number
AFG3000 Series Quick Start User Manual	
English	071-1631-xx
French	071-1632-xx
Italian	071-1669-xx

Table A-3: Optional accessories (cont.)

Accessory	Part number
German	071-1633-xx
Spanish	071-1670-xx
Japanese	071-1634-xx
Simplified Chinese	071-1635-xx
Traditional Chinese	071-1636-xx
Korean	071-1637-xx
Russian	071-1638-xx
Front Panel Overlay	
French	335-1289-xx
German	335-1290-xx
Japanese	335-1291-xx
Simplified Chinese	335-1292-xx
Traditional Chinese	335-1293-xx
Korean	335-1294-xx
Russian	335-1539-xx
AFG3000 Series Programmer Manual (English)	071-1639-xx
AFG3000 Series Service Manual (English)	071-1640-xx
RM3100 Rackmount Kit	RM3100
International Power Cord	
Option A0, North American	161-0066-00
Option A1, European	161-0099-09
Option A2, United Kingdom	161-0099-10
Option A3, Australian	161-0099-13
Option A5, Switzerland	161-0154-00
Option A6, Japanese	161-0298-00
Option A10, China	161-0304-00
50 Ω BNC Termination	011-0049-02
50 Ω BNC Cable, 91 cm (36 in), W shield	012-0482-00
50 Ω BNC Cable, 250 cm (98 in), W shield	012-1256-00
GPIB Interface cable, 2 m, W shield	012-0991-00
Fuse adapter, BNC-P to BNC-R	013-0345-00
Fuse set, 3 pcs, 0.125 A	159-0454-00

Fuse Adapter. The arbitrary/function generator will be damaged if a large DC or AC voltage is applied to the output or input connectors. To protect the output circuits, a fuse adapter is provided as an optional accessory. When the instrument is used by students or other inexperienced users, always attach the fuse adapter to the output connectors to avoid damage.

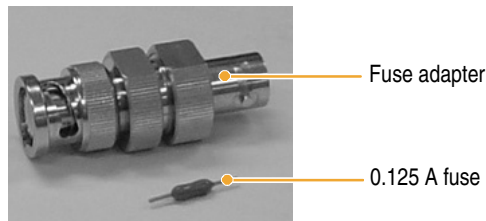

Figure A-1: Fuse adapter

Appendix B: General Care and Cleaning

General Care

Do not store or leave the arbitrary/function generator where the LCD display will be exposed to direct sunlight for long periods of time.



CAUTION. To avoid damage to the arbitrary/function generator, do not expose the instrument to sprays, liquids, or solvents.

Cleaning

Inspect the arbitrary/function generator as often as operating conditions require. To clean the exterior surface, perform the following steps:

1. Remove loose dust on the outside of the instrument with a lint-free cloth. Use care to avoid scratching the clear plastic display filter.
2. Use a soft cloth dampened with water to clean the instrument. Use an aqueous solution of 75% isopropyl alcohol for more efficient cleaning.



CAUTION. To avoid damage to the surface of the instrument, do not use any abrasive or chemical cleaning agents.

Appendix C: SCPI Conformance Information

All commands in the arbitrary/function generator are based on SCPI Version 1999.0. Table C-1 lists the SCPI commands the arbitrary/function generator supports.

Table C-1: SCPI conformance information

Command	Defined in SCPI 1999.0	Not defined in SCPI 1999.0
ABORt	√	
CALibration [ALL](?)	√	
DIAGnostic [ALL](?)		√
DISPlay CONTRast(?)	√	
SAVer [STATe](?)		√
SAVer IMMEDIATE	√	
[WINDow] TEXT [DATA](?)	√	
CLEAr	√	
AFGControl CSCopy		√
HCOPy SDUMp [:IMMEDIATE]	√	
MEMory STATe VALid?		√
DELEte		√
LOCK(?)		√
RECall AUTO(?)		√
MMEMory CATalog?	√	
CDIRectory(?)	√	
DELEte	√	
LOAD STATe	√	
TRACe	√	
LOCK [STATe](?)		√
MDIRectory		√
STORE STATe	√	
TRACe	√	
OUTPut[1 2] IMPedance(?)	√	
POLarity(?)	√	
[STATe](?)	√	
TRIGger MODE(?)		√
[SOURce] ROSCillator SOURce(?)	√	
[SOURce[1 2]] VOLTage CONCurrent [STATe](?)		√
AM STATe(?)	√	
INTernal FREQuency(?)	√	

Table C-1: SCPI conformance information (cont.)

Command			Defined in SCPI 1999.0	Not defined in SCPI 1999.0
		FUNCTION(?)		√
		EFILe(?)		√
		SOURce(?)	√	
		[DEPTh](?)	√	
BURSt		MODE(?)		√
		NCYCLes(?)		√
		TDELay(?)		√
		[STATe](?)		√
COMBine		FEED(?)	√	
FM	INternal	FREQUency(?)	√	
		FUNCTION(?)		√
		EFILe(?)		√
		SOURce(?)	√	
		STATe(?)	√	
		[DEViation](?)	√	
FREQUency		CENTer(?)	√	
	CONCurrent	[STATe](?)		√
		MODE(?)	√	
		SPAN(?)	√	
		STARt(?)	√	
		STOP(?)	√	
		[CW FIXed](?)	√	
FSKey	INternal	RATE(?)		√
		SOURce(?)		√
		STATe(?)		√
		[FREQUency](?)		√
FUNcTION		EFILe(?)		√
	RAMP	SYMMetry(?)		√
		[SHAPe](?)	√	
PHASe		INITiate		√
		[ADJust](?)	√	
PM	INternal	FREQUency(?)	√	
		FUNCTION(?)		√
		EFILe(?)		√
		SOURce(?)	√	
		STATe(?)	√	
		[DEViation](?)	√	
PULSe		DCYCLe(?)	√	

Table C-1: SCPI conformance information (cont.)

Command				Defined in SCPI 1999.0	Not defined in SCPI 1999.0
		DElay(?)		√	
		HOLD(?)		√	
		PERiod(?)		√	
		TRANsition	TRAIling(?)	√	
			[LEADing](?)	√	
		WIDTh(?)		√	
PWM	INTernal	FREQuency(?)			√
		FUNcTion(?)			√
			EFILe(?)		√
		SOURce(?)			√
		STATe(?)			√
		[DEViation]	DCYClE(?)		√
SWEep		HTIME(?)			√
		MODE(?)		√	
		RTIME(?)			√
		SPACing(?)		√	
		TIME(?)		√	
VOLTage	LIMit	HIGH(?)		√	
		LOW(?)		√	
		UNIT(?)			√
		[LEVel]	[IMMediate] HIGH(?)	√	
			LOW(?)	√	
			OFFSet(?)	√	
			[AMPLitude](?)	√	
SOURce<3 4>	POWer	[LEVel]	[IMMediate] [AMPLitude](?)	√	
STATus	OPERation	[EVENT]?		√	
		CONDition?		√	
		ENABle(?)		√	
	PRESet			√	
	QUESTionable	[EVENT]?		√	
		CONDition?		√	
		ENABle(?)		√	
SYSTem	BEEPer	STATe(?)		√	
		[IMMediate]			√
	ERRor	[NEXT]?		√	
	KCLick	[STATe](?)			√
	KLOCK	[STATe](?)		√	
	PASSword	CDISable		√	

Table C-1: SCPI conformance information (cont.)

Command		Defined in SCPI 1999.0	Not defined in SCPI 1999.0
	[CENable]	√	
	STATe?	√	
	NEW	√	
	SECurity IMMEDIATE	√	
	ULANguage(?)		√
	VERSion?	√	
TRACe DATA	CATalog?	√	
	COPY	√	
	[DATA](?)	√	
	LINE	√	
	VALue(?)	√	
	DEFine	√	
	DELete [NAME]	√	
	LOCK [STATe](?)		√
	POINts(?)	√	
TRIGger	[SEQuence] SLOPe(?)	√	
	SOURce(?)	√	
	TIMer(?)	√	
	[IMMEDIATE]	√	
*CAL?			√
*CLS		√	
*ESE(?)		√	
*ESR?		√	
*IDN?		√	
*OPC(?)		√	
*OPT?			√
*PSC(?)			√
*RCL			√
*RST		√	
*SAV			√
*SRE(?)		√	
*STB?		√	
*TRG			√
*TST?		√	
*WAI		√	

Appendix D: Default Setup

Table D-1 lists the settings that are restored when you push the front-panel **Default** button.

Table D-1: Default settings

Menu or System	Default setting
Output configuration	
Function	Sine
Frequency	1.000 000 000 00 MHz
Amplitude	1.000 V _{p-p}
Offset	0 mV
Symmetry (Ramp)	50.0%
Duty (Pulse)	50.0%
Output Units	V _{p-p}
Output Impedance	50 Ω
Output Invert	Off
Output Noise Add	Off
External Add	Off
Modulation	
Modulation Waveform	10.00 kHz, Sine (except FSK)
Modulation Waveform	10.00 kHz, Square (FSK)
AM Depth	50.0%
FM Deviation	1.000 000 MHz
PM Deviation	90.0 °
FSK Hop Frequency	1.000 000 MHz
FSK Rate	50.00 Hz
PWM Deviation	5.0%
Sweep	
Sweep Start Frequency	100.000 kHz
Sweep Stop Frequency	1.000 000 MHz
Sweep Time	10 ms
Sweep Hold Time	0 ms
Sweep Return Time	1 ms
Sweep Type	Linear
Sweep Mode	Repeat
Sweep Source	Internal
Trigger Slope	Positive
Trigger Interval	1.000 ms

Table D-1: Default settings (cont.)

Menu or System	Default setting
Burst	
Burst Mode	Triggered
Burst Count	5
Trigger Source	Internal
Trigger Delay	0.0 ns
Trigger Interval	1.000 ms
System-related settings	
Trigger Out	Trigger
Clock Reference	Internal
Access Protection	Off

The front-panel **Default** button does not reset the following settings:

- Language option
- Power-on settings
- Display contrast
- Screen saver
- Click tone
- Beeper
- Saved setup files
- Saved waveform files
- Calibration data
- GPIB setup
- Ethernet setup
- Access protection

Appendix E: Reference

This section describes the menus associated with each front-panel menu button or control.

Menu System

The user interface of the AFG3000 Series Arbitrary/Function Generators was designed for easy access to specialized functions through the menu structure.

When you push a front panel-button, the arbitrary/function generator displays the corresponding menu on the right side of the screen. The menu shows the options that are available when you push the unlabeled bezel buttons directly to the right of the screen. (Some documentation may also refer to the bezel buttons as side-menu buttons or soft keys.)

Using the Menu System

The arbitrary/function generator uses the following methods to display menu options:

Submenu Selection. For some menus, you can use the bezel button to choose the submenus. For example, when you push the **I/O Interface** bezel button in the Utility menu, the arbitrary/function generator displays the I/O Interface submenu (GPIB or Ethernet).

Action. The arbitrary/function generator displays the type of action that will immediately occur when you push an action bezel button. For example, when you push the front-panel **Save** button and then push the **Save** bezel button, the arbitrary/function generator saves the settings immediately.

Option Buttons. The arbitrary/function generator uses a different button for each option. The currently selected option is highlighted. For example, the instrument displays various language options when you push the **Utility** menu button and then push the **Language** bezel button. To select the option, push the corresponding button. Option button is also called radio button.

Toggle. For some menus, pushing a bezel button will toggle the corresponding menu options. For example, when you push the **Power On** bezel button in the Utility menu, it will toggle between **Default** and **Last**. Pushing the **Beeper** bezel button will toggle between **On** and **Off**.

Menu Structure

This section describes the menus and operating details associated with each front-panel menu button.

- Sine/Square Menu, page E-3
- Ramp Menu, page E-4
- Pulse Menu, page E-4
- Arb Menu, page E-5
- More... Menu, page E-6
- Run Mode Menus
 - Continuous (No bezel menu for Continuous mode)
 - Modulation Parameter Menu, page E-7
 - Sweep Parameter Menu, page E-9
 - Burst Parameter Menu, page E-11
- Output Menu, page E-12

NOTE. To access the Output menu, push the front-panel Top Menu button. The arbitrary/function generator does not have the Output menu button on the front panel. Refer to page 1-3 for the Top Menu button.

- Save/Recall Menu, page E-13
- Edit Menu, page E-14
- Utility Menu, page E-23

Sine/Square Menu Table E-1 shows the **Sine** and **Square** menu.

Table E-1: Sine/Square menu

First level	Second level	Third level	Description
Frequency/Period/ Phase Menu	Frequency		Selects Frequency as a parameter to be changed.
	Period		Selects Period as a parameter to be changed.
	Frequency (Period) ¹ CH1=CH2 Off On		Toggles between Off and On to disable/enable the function that sets the CH1 and CH2 to the same value.
	Phase		Selects Phase as a parameter to be changed.
	Align Phase ¹		Use to align the phase of two channel signals.
Amplitude/Level Menu	Amplitude		Selects Amplitude as a parameter to be changed.
	Offset		Selects Offset as a parameter to be changed.
	High Level		Selects High Level as a parameter to be changed.
	Low Level		Selects Low Level as a parameter to be changed.
	-more- (1 of 2)		
	Units [Vpp]	Vpp Vrms dBm ²	Option buttons
	Level ¹ CH1=CH2 Off On		Toggles between Off and On to disable/enable the function that sets the CH1 and CH2 to the same value.
	-more- (2 of 2)		
Run Mode Menu	Continuous		—
	Modulation		Refer to Table E-6
	Sweep		Refer to Table E-7
	Burst		Refer to Table E-8
Output Menu			Refer to Table E-9

1. Dual-channel model only.
2. dBm is used only for sine waveform.

Ramp Menu Table E-2 shows the **Ramp** menu.

Table E-2: Ramp menu

First level	Second level	Description
Ramp Parameter Menu	Symmetry	Sets the Ramp waveform symmetry to your desired value.
	Set to 0%	Sets the Ramp waveform symmetry to 0%.
	Set to 50%	Sets the Ramp waveform symmetry to 50%.
	Set to 100%	Sets the Ramp waveform symmetry to 100%.
Frequency/Period/Phase Menu		Refer to Table E-1
Amplitude/Level Menu		Refer to Table E-1
Run Mode Menu	Continuous	—
	Modulation	Refer to Table E-6
	Sweep	Refer to Table E-7
	Burst	Refer to Table E-8
Output Menu		Refer to Table E-9

Pulse Menu Table E-3 shows the **Pulse** menu.

Table E-3: Pulse menu

First level	Second level	Description
Pulse Parameter Menu	Duty	Selects Duty as a parameter to be changed.
	Width	Selects Width as a parameter to be changed.
	Leading Edge	Selects Leading Edge as a parameter to be changed.
	Trailing Edge	Selects Trailing Edge as a parameter to be changed.
Frequency/Period/Delay Menu	Frequency	Selects Frequency as a parameter to be changed.
	Period	Selects Period as a parameter to be changed.
	Frequency (Period) ¹ CH1=CH2 Off On	Toggles between Off and On to disable/enable the function to set the CH1 and CH2 to the same value.
	Lead Delay	Selects Lead Delay as a parameter to be changed.
	Recover Lead Delay ¹	Use to align the lead delay of two channel signals.
Amplitude/Level Menu		Refer to Table E-1
Run Mode Menu	Continuous	—
	Modulation	Refer to Table E-6
	Burst	Refer to Table E-8
Output Menu		Refer to Table E-9

1. Dual-channel model only.

Arb Menu The arbitrary/function generator can output a user-defined waveform that is stored in the internal memory, Edit Memory, or a USB memory. Table E-4 shows the **Arb** menu.

Table E-4: Arb menu

First level	Second level	Description
Arb Waveform Menu	Memory Internal USB	Selects a memory type. (Internal or USB) Refer to page E-30 for file operations.
	(blank)	
	Change Directory	Opens a directory in a USB memory.
	OK	
	Cancel	
Frequency/Period/ Phase Menu		Refer to Table E-1
Amplitude/Level Menu		Refer to Table E-1
Run Mode Menu	Continuous	—
	Modulation	Refer to Table E-6
	Sweep	Refer to Table E-7
	Burst	Refer to Table E-8
Output Menu		Refer to Table E-9

To output a user-defined waveform, you have two options:

- Output the contents of Edit Memory
- Output one of user-defined waveforms stored in the internal or in a USB memory

To output a user-defined waveform, you must first save the file in the internal or USB memory. You can save up to four user-defined waveforms in the internal waveform memory. Waveform data in the Edit Memory can also be output, but the contents of Edit Memory is deleted when the instrument power is turned off.

NOTE. When the arbitrary/function generator outputs an Arb waveform, the peak-to-peak voltage of the measurement result is the same as the setup value if the waveform data is normalized.

More... Menu Table E-5 shows the **More...** menu.

Table E-5: More menu

First level	Second level	Description
More Waveform Menu	Sin(x)/x	Option buttons
	Noise	
	DC	
	Gaussian	
	-more- (1 of 2)	
	Lorentz	Option buttons
	Exponential Rise	
	Exponential Decay	
	Haversine	
	-more- (2 of 2)	
Frequency/Period/ Phase Menu		Refer to Table E-1
Amplitude/Level Menu		Refer to Table E-1
Run Mode Menu	Continuous	—
	Modulation	Refer to Table E-6
	Sweep	Refer to Table E-7
	Burst	Refer to Table E-8
Output Menu		Refer to Table E-9

NOTE. When the arbitrary/function generator outputs Sin(x)/x, Gaussian, Lorentz, Exponential Rise, Exponential Decay, or Haversine waveforms, the peak-to-peak voltage is defined as twice the 0 to peak value.

Modulation Parameter Menu

Table E-6 shows the Modulation Parameter Menu.

Table E-6: Modulation parameter menu

First level	Second level	Description
Modulation Type [AM]	AM FM PM FSK PWM	Selects modulation type.
[AM] Source Internal External		Selects modulation source (internal or external) for AM, FM, PM, FSK, or PWM.
AM, FM, PM, PWM Frequency, or FSK Rate		Sets modulation frequency or FSK rate.
Modulation Shape ¹	Memory Internal USB	Selects a memory type (internal or USB).
	(blank)	
	Change Directory	Opens a directory in a USB memory.
	OK	
	Cancel	
Depth/Deviation/ Hop Frequency		Sets modulation depth for AM, deviation for FM and PM, or Hop Frequency for FSK.

1. If you specify Internal as the memory type, you can select the modulation shape from the following:

- Sine
- Square
- Triangle
- Up Ramp
- Down Ramp
- Noise
- Arb (User1 to User4)
- Edit Memory

Amplitude Modulation. Amplitude modulation is a modulation technique in which the amplitude of the carrier frequency is modified by the amplitude of the modulating waveform (internal or external modulation source).

The modulation depth is expressed as a percentage and represents the extent of the amplitude variation.

Frequency Modulation. Frequency modulation is a modulation technique in which the carrier frequency is modified by the amplitude of the modulating waveform.

The carrier frequency must always be greater than or equal to the deviation. Also the sum of the carrier frequency and deviation must be less than or equal to the maximum frequency for the selected waveform.

Phase Modulation. Phase modulation is similar to FM (Frequency modulation), but in PM, the phase of the carrier waveform is varied by the amplitude of the modulating waveform.

Frequency Shift Keying. Frequency shift keying modulation is a modulation technique that shifts the output signal frequency between two frequencies: the carrier frequency and the FSK Hop frequency.

Pulse Width Modulation. Pulse width modulation is a modulation technique in which the width of a pulse waveform is varied by the voltage of the modulating waveform.

Sweep Parameter Menu

Table E-7 shows the Sweep Parameter Menu.

Table E-7: Sweep parameter menu

First level	Description
Start Frequency	Numeric input. Sets start frequency.
Stop Frequency	Numeric input. Sets stop frequency.
Sweep Time	Numeric input. Sets sweep time.
Return Time	Numeric input. Sets return time.
-more- (1 of 3)	
Center Frequency	Numeric input. Sets center frequency.
Span	Numeric input. Sets frequency span.
Hold Time	Numeric input. Sets hold time.
Type Linear Logarithm	Selects sweep type (Linear or Logarithm). See Figure E-1.
-more- (2 of 3)	
Mode Repeat Trigger	Selects sweep mode (Repeat or Trigger).
Source Internal External	Selects trigger source (Internal or External).
Slope Positive Negative	Selects trigger slope (Positive or Negative). Available only when you select External as a trigger source.
Trigger Interval	Numeric input. Sets trigger interval. Available only when you select Internal as a trigger source.
-more- (3 of 3)	

The sweep function outputs a waveform with the output signal frequency varying linearly or logarithmically.

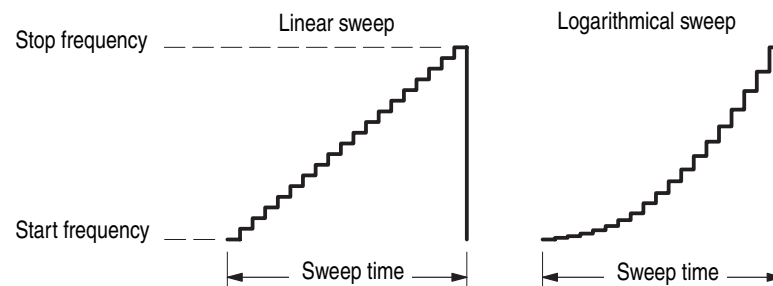
**Figure E-1: Sweep type**

When sweep is taking place, the frequency sweeps from start frequency to stop frequency. Refer to Figure E-2.

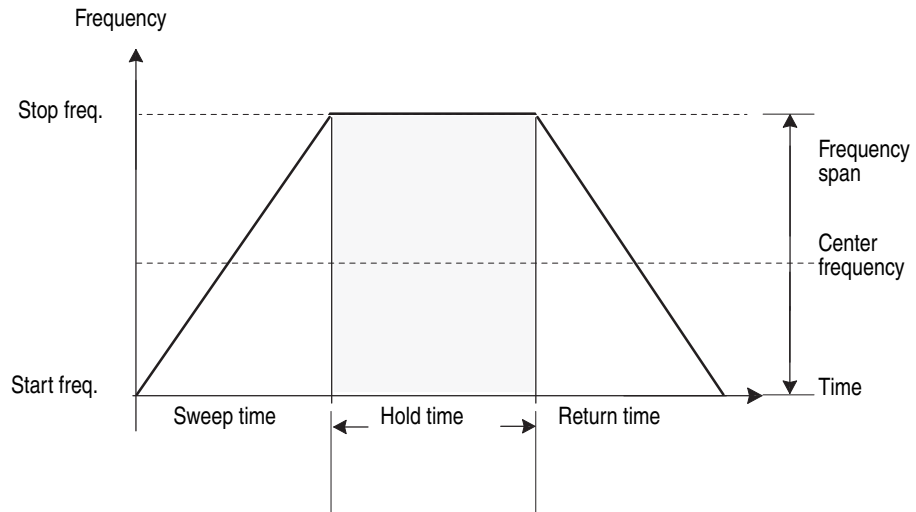

Figure E-2: Frequency sweep

The instrument sweeps from a low frequency to a high frequency when start frequency is set to be lower than stop frequency (start frequency < stop frequency).

The instrument sweeps from a high frequency to a low frequency when start frequency is set to be higher than stop frequency.

The frequency range differs based on the selected waveform types. For frequency sweep, you can select a sine, square, ramp, or arbitrary waveform. Pulse, DC, and Noise waveforms cannot be selected.

You can select one of the following two operation modes:

Repeat. A continuous sweep is output at a rate specified by the sweep time, hold time, and return time.

Trigger. One sweep waveform is output when a trigger input is received.

You can select a trigger source from an external signal applied to the front-panel Trigger Input connector, the trigger signal generated internally, the manual trigger, or the remote interface.

Burst Parameter Menu

Table E-8 shows the Burst Parameter Menu.

Table E-8: Burst parameter menu

First level	Description
1-Cycle	Sets burst count to 1.
N-Cycle	Sets burst count to N. (N=1 to 1,000,000)
Inf-Cycle	Sets burst count to Infinite.
Gate	Selects gated burst mode.
-more- (1/2)	
Delay	Sets trigger delay between the receipt of the trigger and the start of the burst waveform. The range is 0 to 500 s.
Source Internal External	Select trigger source (Internal or External).
Slope Positive Negative	Selects trigger slope (Positive or Negative). Available only when you select External as a trigger source.
Trigger Interval	Sets trigger interval. Available only when you select Internal as a trigger source.
-more- (2/2)	

Triggered Burst Mode. When a trigger event occurs in the burst mode, the waveform is output for the number of cycles specified by the Burst Parameter Menu. Once the triggered burst mode is selected, the arbitrary/function generator will wait for a trigger event to occur.

A specified number (burst count) of waveform cycles are output when the instrument receives a trigger input from the internal trigger source, an external trigger source, a remote command, or the Manual Trigger button.

Gated Burst Mode. In the gated burst mode, the output is enabled or disabled based on the internal gate signal, an external signal applied to the front panel Trigger Input connector, or a remote command. While the gate signal is true or the front panel Manual Trigger button is depressed, the instrument outputs a continuous waveform.

When the trigger source is set to **Internal**, the trigger interval can be set. The setting range of trigger interval is 1 ms to 500 s. The default is 1 ms.

When the trigger source is set to **External**, you can select Positive or Negative as the trigger slope. The instrument will trigger on the rising edge (Positive) or falling edge (Negative) of the signal applied to the front-panel Trigger Input connector.

Output Menu

Table E-9 shows the Output Menu. To access the Output menu, push the front-panel Top Menu button, and then push the bottom bezel button.

Table E-9: Output menu

First level	Second level	Description
Load Impedance	50 Ω	Option buttons. Set the load impedance to 50 Ω .
	Load ¹	Option buttons & Numeric input. You can set the load impedance to any value from 1 Ω to 10 k Ω .
	High Z	Option buttons. Select high impedance.
Invert Off On		Selects Invert On to invert a waveform polarity.
Limit	High Limit	Numeric input.
	Low Limit	Specifies the higher and lower amplitude limit. See <i>Level Meter</i> on page 1-12.
Noise	Noise Add Off On	Selects Noise Add On to add the internal noise to a waveform.
	Noise Level ²	Sets the noise level.
External Add ³ Off On		When CH1 is selected: Selects External Add On to add an external signal to the CH 1 output signal.
CH1 Complement ⁴		When CH2 is selected: The CH2 waveshape and timing parameters are copied from CH1, and the CH2 amplitude settings are inverted from CH1.

1. Range: 1 Ω to 10 k Ω .
When dBm is currently selected for output amplitude units, the amplitude units setting is automatically changed to V_{p-p} if you select high impedance.
2. Range: 0% to 50% of amplitude setting (V_{p-p}) of signal waveform, resolution 1%
The maximum value of noise range is limited by waveform and amplitude range.
3. AFG310x and AFG325x series only.
4. Dual-channel model only.

Load Impedance. The output impedance of the AFG3000 series is 50 Ω . If you connect a load other than 50 Ω , the displayed Amplitude, Offset, and High/Low values are different from the output voltage. To make the displayed values same as output voltage, you need to set load impedance.

Noise Add. When you set Noise Add to On, the amplitude of output signal is reduced to 50%.

CH1 Complement. A dual-channel instrument can be used to generate a differential signal by programming CH2 to output the complement of CH1.

Save/Recall Menu The **Save** and **Recall** menus store or recall arbitrary/function generator setups. The setups are stored in either internal setup memory or USB memory.

Table E-10: Save/Recall menu

Save or Recall	First level	Second level	Description
Save	Memory Internal USB		Selects a memory type (Internal or USB).
	Save		Saves the instrument settings to the specified setup memory location.
	Save As	Enter Character	Refer to page E-34 for entering a file name.
		OK	
		Cancel	
	Change Directory		Opens a directory.
	-more- (1/2)		
	Lock/Unlock		Locks or unlocks a file.
	Erase		Erases a file.
	(blank)		
Make Directory	Enter Character	Refer to page E-30 for file operations.	
	OK		
	Cancel		
	-more- (2/2)		
Recall	Memory Internal USB		Selects a memory type (Internal or USB).
	Recall		Recalls the instrument settings from the specified file.
	(blank)		
	Change Directory		Opens a directory.
	(blank)		

The arbitrary/function generator has four storage locations in non-volatile memory to store the instrument setups. The locations are numbered 1 through 4. The instrument uses location 0, which is called “last setup memory”, to overwrite the instrument setups at power off.

You can select the instrument settings that are restored when you power on the instrument. If you select **Power On Last** in the Utility menu, the instrument will restore the last powered-off settings the next time you power on the instrument. (See the Utility Menu on page E-23.)

The **Lock/Unlock** menu allows you to lock the file against accidental overwrite. When a memory location is locked, a lock icon appears on the screen.

Edit Menu The **Edit** menu is used to create or edit user-defined waveforms and to import or export waveforms. To output a user-defined waveform, waveform data must be created in the Edit Memory and then stored in the internal or a USB memory. Although you can output the content of Edit Memory, the content of Edit Memory will be deleted when the instrument is powered off.

There are three ways to create a waveform in the Edit Memory:

- Create a waveform file using the Edit Menu
- Copy a waveform file using remote commands
- Import a waveform file using the ArbExpress software

Table E-11: Edit menu

First level	Second level	Description
Number of Points		Sets the number of points of waveform to be created or the length of edit memory. The default is 1000.
New	Sine	Writes a standard waveform to Edit Memory. (The contents of Edit Memory will be overwritten.) You can select a waveform from five standard waveforms. The written waveform has the number of points specified by the Number of Points bezel menu.
	Square	
	Pulse	
	Ramp	
	Noise	
Operation	Line	Opens Line submenu. See Table E-12.
	Data	Opens Data submenu. See Table E-12.
	Cut	Opens Cut submenu. See Table E-12.
	(blank)	
	(blank)	
Read from...	Memory Internal USB	Selects a memory type (Internal or USB).
	Read	Load one of the user-defined waveforms, which is stored in the internal or USB memory, to Edit Memory. Once Read is executed, the edit waveform is overwritten.
	(blank)	
	Change Directory	Opens a directory. This menu item is available when USB is selected.
	Cancel	
-more- (1/3)		

Table E-11: Edit menu (cont.)

First level	Second level	Description
Paste at Beginning	Memory Internal USB	Selects a memory type (Internal or USB).
	Paste	Pastes a waveform at the beginning of the current waveform.
	(blank)	
	Change Directory	Opens a directory. This menu item is available when USB is selected.
	Cancel	
Paste at End	Memory Internal USB	Selects a memory type (Internal or USB).
	Paste	Pastes a waveform at the end of the current waveform.
	(blank)	
	Change Directory	Opens a directory. This menu item is available when USB is selected.
	Cancel	
(blank)		
Write to...	Memory Internal USB	Selects a memory type (Internal or USB).
	Write	Saves the current waveform to the internal or USB memory.
	Write As	Opens the submenu to enter a file name. See page E-32.
	Change Directory	Opens a directory. This menu item is available when USB is selected.
	-more- (1/2)	
	Lock/Unlock	Locks or unlocks a file.
	Erase	Erase a file.
	(blank)	
	Make Directory	Creates a new directory. This menu item is available when USB is selected.
	-more- (2/2)	
-more- (2/3)		
Zoom Fit		Adjusts the graph scale and display the complete waveform cycle.
(blank)		
(blank)		
(blank)		
-more- (3/3)		

Number of Points. This bezel menu sets the number of points of the waveform to be created or the length of Edit Memory. The point can be set to a value in the following range:

■ Waveform Length: 2 to 131,072

If a waveform is already written to Edit Memory and **Number of Points** is set to a value smaller than the number of points in that waveform, then the data for the points starting at that value plus one will be lost. For example, if **Number of Points** is set to 500 in the state where a waveform with 1000 points has been written to Edit Memory, the waveform data for points 1 to 500 will remain without change but the data from point 501 will be lost.

If a waveform is already written to Edit Memory and **Number of Points** is set to a value greater than the number of points in that waveform, then the data for the points starting at that value plus one to the point identified by the **Number of Points** will be set to the zero level. For example, if **Number of Points** is set to 1500 in the state where a waveform with 1000 points has been written to Edit Memory, the waveform data for points 1 to 1000 will remain without change and the data from point 1001 to point 1500 will be set to zero level. See Figure E-3 for an example using the **Number of Points** parameter.

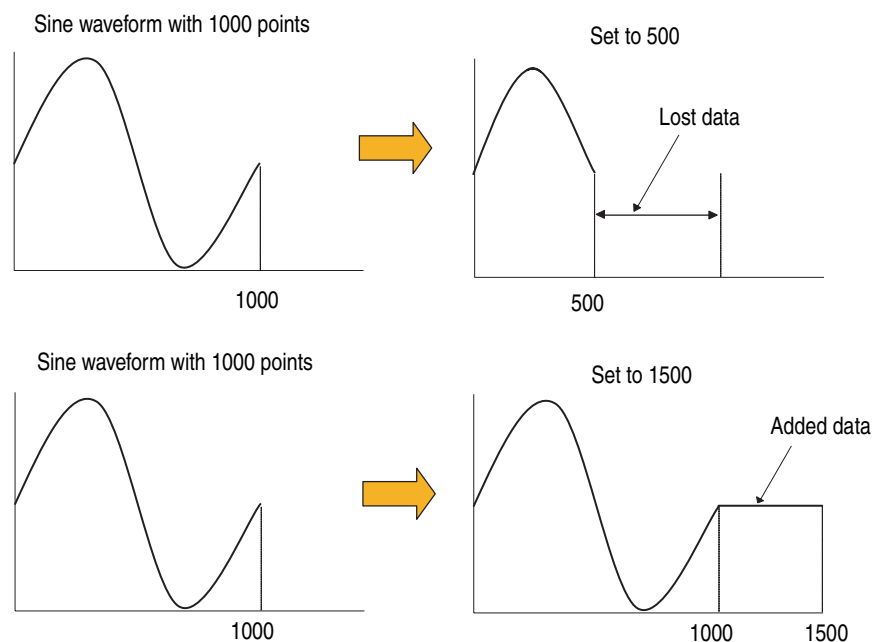

Figure E-3: Number of Points

New. Pushing the **New** bezel button will display a standard waveform selection submenu. You can select a standard waveform from five waveform types (Sine, Square, Pulse, Ramp, and Noise). For example, selecting **Sine** will write a sine

waveform into Edit Memory. The waveform has the number of points specified by the **Number of Points** bezel menu. If waveform data is already stored in the Edit Memory, the existing waveform data will be lost, and the new waveform will overwrite the old data.

Operations Submenu (Line, Data, and Cut). For each of the **Operations** submenus, you must push the **Execute** bezel button to implement the edit operation.

Table E-12: Operations submenu

First level	Second level	Description
Line	From X1	Use to edit a line linearly by interpolating from a specified point in the waveform currently being edited to another specified point.
	Y1	
	To X2	
	Y2	
	Execute	
Data	X	Use to change the specified data point in the waveform currently being edited.
	Y	
	(blank)	
	(blank)	
	Execute	
Cut	From X1	Use to delete an area between specified points in the waveform currently being edited.
	(blank)	
	To X2	
	(blank)	
	Execute	
(blank)		
(blank)		

Using the Cursors. You can use cursors to edit a waveform. To use cursors, select the **Operations** submenu in the **Edit** menu. Figure E-4 is a sample of **Line** edit screen.

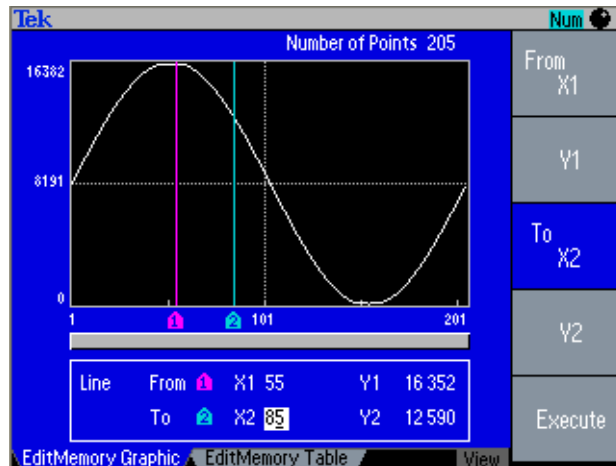

Figure E-4: Using the Cursor (Line edit)

In the **Line** edit screen, there are two cursor types: X1 cursor and X2 cursor. Use the **From X1** or **To X2** bezel button to select which cursor to move. To move the X1 cursor, push the **From X1** bezel button and then turn the general purpose knob. Or, you can enter a value for the point X1 using the numeric keypad. Entering a value and then pushing the front-panel **Enter** button will move the cursor to the specified point. To move the X2 cursor, push the **To X2** bezel button and then turn the knob or enter a value.

After specified two points, push the **Execute** bezel button to implement the edit operation. The **Line** edit is applied to the portion between the two cursors (X1 and X2).

When you select **Operations > Data**, only one cursor is displayed. The edit operation is applied to the specified point.

When you select **Operations > Cut**, two cursors are displayed like **Line** edit. The edit operation is applied to the portion between the two cursors.

Line (Line Edit). The **Line** edits by linearly interpolating from a specified point in the waveform currently edited to another specified point as shown in Figure E-5.

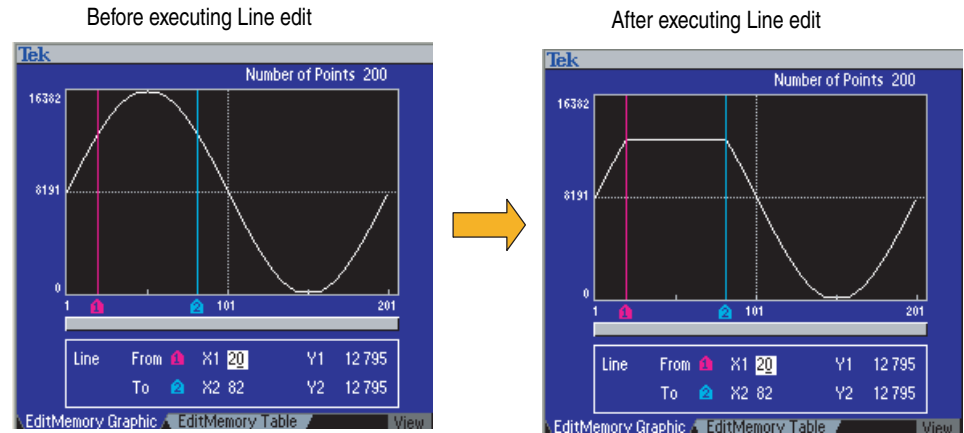

Figure E-5: Line Edit example

Data (Edit by Data Point). The **Data** edits a specified point in the waveform currently being edited.

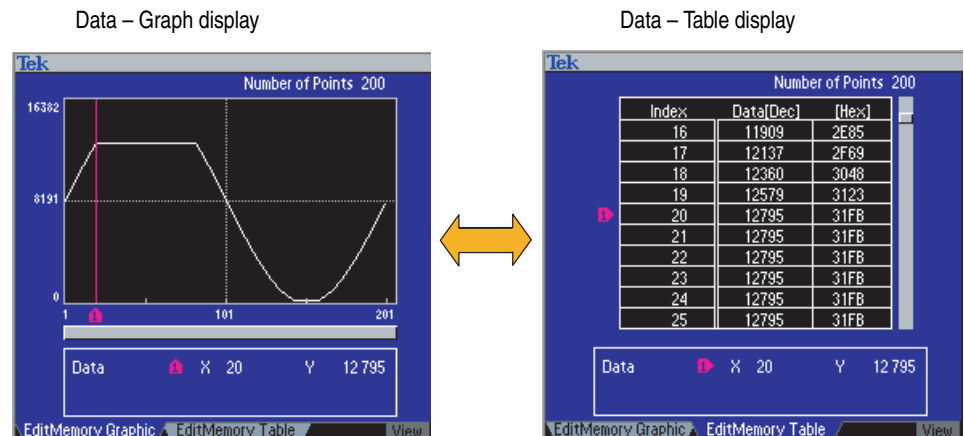

Figure E-6: Operation – Edit by Data Point

If you enter a number that exceeds the number of points in the current waveform, the entered value will be automatically changed to the number of points in the current waveform.

If you push the **Execute** bezel button in the **Data** operation, the instrument will auto-increment to the next point. For example, you specify a data point X and then push **Execute**, the instrument will automatically move from point X to X + 1 in anticipation of your next input.

Cut (Cut by Data Points). The **Cut** deletes an area between specified points in the waveform. When **Cut** is selected, two values can be input (From X1 and To X2). See Figure E-7.

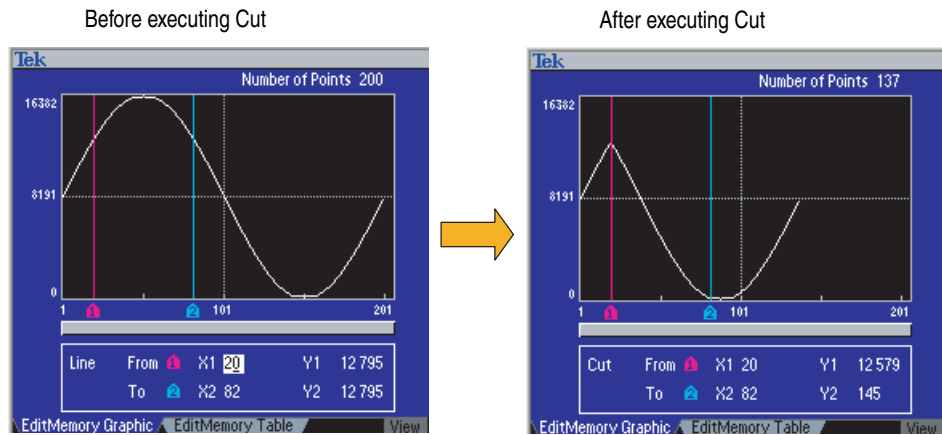

Figure E-7: Cut example

NOTE. Data that has been deleted cannot be recovered.

Read from... Push the front-panel **Edit** button and then push the **Read from... > Memory** bezel menu to load a waveform file from the internal memory or a USB memory into Edit Memory.

Paste at Beginning. The **Paste at Beginning** inserts the contents of the user waveform memory (User1, User2, User3, or User4), USB memory, or the current contents of Edit Memory at the beginning of the waveform that is currently being edited. When this operation is executed, the Number of Points setting is automatically modified. If this operation would cause the waveform to exceed 131,072 points, the waveform insertion will not be executed.

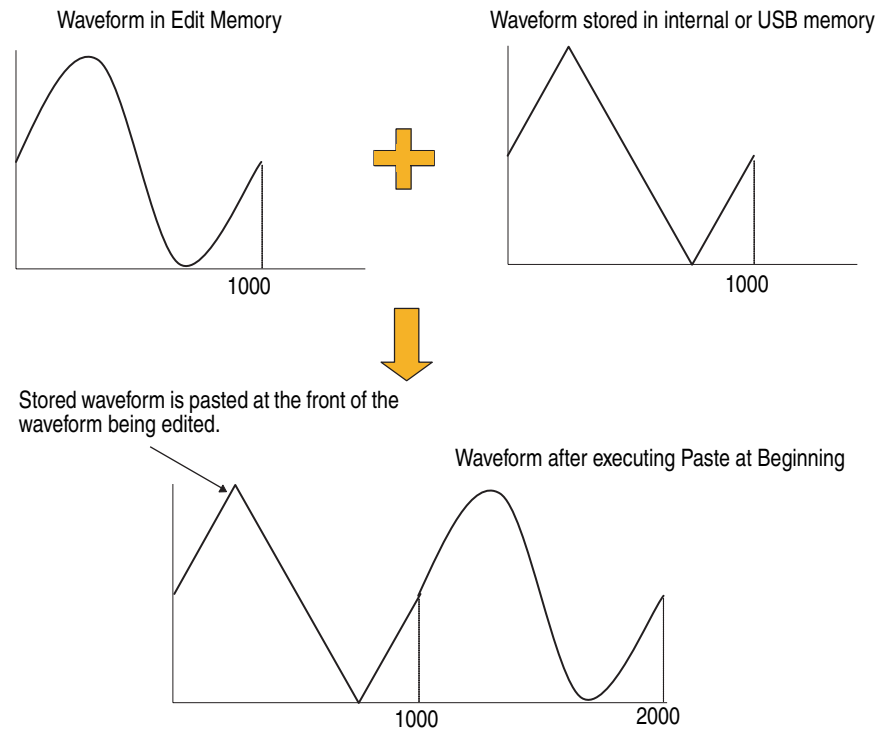

Figure E-8: Paste at Beginning

Paste at End. The **Paste at End** appends the contents of the user waveform memory (User1, User2, User3, or User4), USB memory, or the current contents of edit memory at the end of the waveform currently being edited. When this operation is executed, the Number of Points setting is automatically modified. If this operation would cause the waveform to exceed 131,072 points, the waveform append will not be executed.

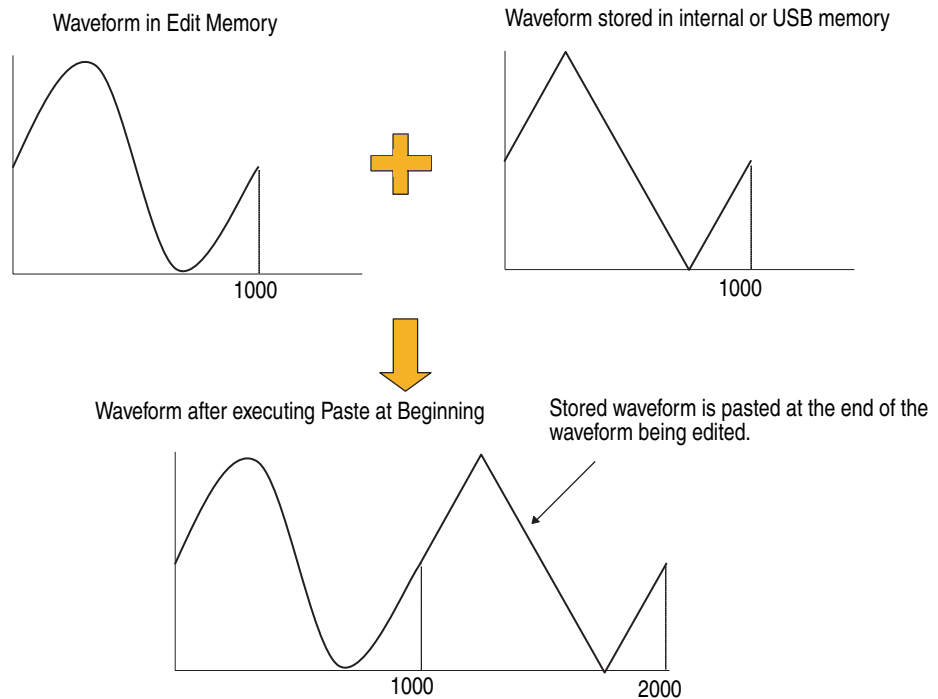

Figure E-9: Paste at End

Write to... The currently edited waveform is in Edit Memory. If the instrument power is turned off, the contents of Edit Memory will be lost. To allow this waveform to be used the next time the power is turned on, the contents of Edit Memory must be saved into the user waveform memory or a USB memory.

For more information on saving a user-defined waveform file, refer to *Saving a Waveform File* on page E-31.

Utility Menu The **Utility** menu provides access to utilities used by the arbitrary/function generator such as language selection, instrument diagnostics, and user preferences.

Table E-13: Utility menu

First level	Second level	Third level	Description
I/O Interface	GPIB	Address	Sets the instrument GPIB address.
		Configuration Talk/Listen Off Bus	Select Talk/Listen to enable the GPIB bus communication. Select Off Bus to isolate the instrument from the GPIB bus communication.
	Ethernet ¹	IP Address	Sets an IP address manually.
		Subnet Mask	Sets a subnet mask manually.
		Default Gateway	Sets a default gateway manually.
		DHCP ² Off On	Select DHCP On to assign an IP Address automatically. Select DHCP Off to assign an IP Address manually.
	Language	English	Selects a language to display on the instrument screen. After selecting a desired language, the bezel menu, pop-up message, and built-in help are displayed in the selected language. The main display area (see page 1-11) is not translated.
		French	
		German	
		Japanese	
-more- (1 of 2)			
Korean			
Simplified Chinese			
Traditional Chinese			
Russian			
-more- (2 of 2)			

Table E-13: Utility menu (cont.)

First level	Second level	Third level	Description
System	Trigger Out Trigger Sync	Select Trigger to generate the trigger signal for the oscilloscope. Select Sync to synchronize multiple AFG3000 series instruments.	
	Clock Ref Internal External	Select Internal to accept the internal reference clock. Select External to accept an external reference clock.	
	Power On Default Last	Select Default to set the instrument power-on status to the default settings. Select Last to set the instrument power-on status to the last powered-off settings.	
	Secure	Select Secure to erase all data except Mac Address, calibration data, and the instrument serial number.	
	-more- (1 of 2)		
	Contrast	Select Contrast to change the instrument display contrast.	
	Screen Saver Off On	Select Screen Saver Off to deactivate the screen saver. Select Screen Saver On to activate the screen saver.	
	Click Tone Off On	Select Click Tone Off to deactivate the click sound. Select Click Tone On to activate the click sound.	
	Beeper Off On	Select Beeper Off to deactivate the beeper sound. Select Beeper On to activate the beeper sound.	
	-more- (2 of 2)		
Status	Setup	Select Setup to list the CH1 and CH2 waveform parameter configuration.	
	Misc.	Select Misc. to list the instrument network configuration and user preferences.	
	(blank)		
	Page Up	Returns to previous page.	
	Page Down	Moves to next page.	
-more- (1 of 3)			

Table E-13: Utility menu (cont.)

First level	Second level	Third level	Description
Diagnostics/ Calibration	Execute Diagnostics	Performs the instrument diagnostics.	
	Execute Calibration	Performs the instrument self calibration.	
Backup/ Restore ³	Type Setup Arb	Selects file type (Setup or Arb).	
	Backup Internal -> USB Memory	Copies the contents of internal memory to a USB memory.	
	Restore Internal <- USB Memory	Copies the files in the USB memory to the internal memory.	
	Change Directory	Opens a directory in a USB memory.	
	Make Directory	Creates a new directory in a USB memory.	
Channel Copy	CH1 -> CH2	Copies the CH1 waveform parameter settings to CH2.	
	CH2 -> CH1	Copies the CH2 waveform parameter settings to CH1.	
(blank)			
-more- (2 of 3)			
Firmware Update ³	Execute	Performs the instrument firmware update.	
	(blank)		
	(blank)		
	Change Directory	Opens a directory in a USB memory.	
	Cancel		
(blank)			
Security Menu	Access Protection	Enter Character	Use Security Menu to limit access to Firmware update.
		OK	
		Cancel	
	Change Password	Enter Character	Opens Change Password page.
		OK	
		Cancel	
-more- (3 of 3)			

1. To connect your instrument to a network, you must first obtain information from your network administrator. The procedure for entering the Ethernet network parameters depends on your network configuration.
2. If your network supports DHCP (Dynamic Host Configuration Protocol), select the DHCP On so that the instrument can automatically set its network address through DHCP.
3. These menus are available only when a USB memory is inserted correctly to the instrument.

Connecting to a GPIB Network. The GPIB Interface can be used for remotely controlling the arbitrary/function generator from an external device (such as a PC). Refer to *Syntax and Commands* on page 2-1 for information about remote control commands.

Connecting to a Ethernet Network. To connect the arbitrary/function generator to a LAN, use a 10 Base-T or 100 Base-T cable. Connect a LAN cable to the LAN port on the rear panel. See page 1-19 for the location of the LAN port.

Synchronous Operation. By synchronizing multiple arbitrary/function generators, you can configure the multichannel arbitrary/function generator. To synchronize multiple arbitrary/function generators, connect the instruments as follows:

- Use a BNC cable to connect the front-panel Trigger Output connector of the master unit and the Trigger Input connector of the slave unit.
- Use another BNC cable to connect the EXT REF OUTPUT connector on the rear panel of the master unit and the EXT REF INPUT connector of the slave unit.

NOTE. *The EXT REF OUTPUT connector is not present on the AFG3021B and AFG3022B rear panel.*

1. Push the front-panel **Utility** button, and then push the **System** bezel button to display the System menu.
2. Set the master unit as follows:
 - Trigger Out – **Sync**
 - Clock Ref – **Internal**
3. Set the slave unit as follows:
 - Clock Ref – **External**
4. Select **Burst** as the Run Mode for both the master and slave units.
5. Push the **-more-** bezel button of the slave unit, and select **External** as (trigger) Source.

To synchronize multiple instruments, you must stop running output signals once before triggering using the Burst mode.

Power-on Setting. You can select the arbitrary/function generator settings that are restored when the instrument is powered on. By default, the arbitrary/function generator is set to restore the default settings at power-on. To change the power-on settings, use the **Utility > System > Power On** bezel menu. To restore the last powered-off settings next time you power on the instrument, select **Last**.

Secure. The **Secure** function erases all the waveform/setup data in the internal memory. This is sometimes useful when you are storing data that is confidential and you must transport the instrument for servicing or demonstrations.



CAUTION. Executing **Secure** will erase all setups and waveform data files in the internal memory. Make sure you want to remove all data before execution. You cannot recover the deleted files.

Diagnostics and Calibration. From the Utility menu, you can perform the self test and self calibration routine.

The self test can be performed by selecting the **Utility > -more- > Diagnostics/Calibration > Execute Diagnostics** bezel menu. The test checks whether the instrument is operating correctly. These diagnostics can be helpful when repairing the instrument.

The self calibration allows the instrument to operate with correct precision.

NOTE. The self calibration must be executed at an ambient temperature of between +20 °C and +30 °C (+68 °F to +86 °F), when a warm-up period of approximately 20 minutes has passed.



CAUTION. Do not power off the instrument during self calibration.

Backup/Restore. The **Backup** function is provided for copying the current arbitrary/function generator information (instrument setups or user-defined waveforms) to a USB memory with a single button push. Pushing the **Backup Internal -> USB Memory** button will copy the internal memory contents to a USB memory.

The **Restore** function is provided for copying the contents of USB memory to the internal memory.

Firmware Update. You can use the Utility menu to update your arbitrary/function generator instrument firmware. If Tektronix offers a newer version of firmware, download the firmware file to your USB memory from the Tektronix Web site.

1. Go to www.tektronix.com.
2. Download a newer version of firmware to your PC.
3. Unzip the downloaded file, and copy the file to your USB memory.
4. Connect the USB memory to your arbitrary/function generator.
5. Push the front-panel **Utility** button.
6. Push the **-more-** bezel button twice, and then select **Firmware Update**.
7. Select the downloaded firmware file and then push the **Execute** bezel button.
8. After the update, power the instrument off and then back on to activate the new firmware.

NOTE. *To check your instrument firmware version, push the front-panel **Utility** button. The version information is displayed on the screen.*



CAUTION. *Updating your instrument firmware is a sensitive operation, which may damage your instrument if you do not follow the instructions carefully.*

To prevent damage to the instrument, do not remove the USB memory or power off the instrument during the update process.

Security Menu. Use the Security menu to limit access to the following menus:

- Firmware update
- Service menu. (Refer to the service manual for information about the service menu.)

The access protection is set to off by default. To turn the access protection on, do the following steps:

1. Push the front-panel **Utility** button, and then select Security Menu.
2. Select **Access Protection** to display the password input page.
3. Enter your password.

Use the general purpose knob to select the characters and push the **Enter Character** bezel button after each selection. As you enter the characters of your password, they are displayed as a series of asterisks (*****) on the password input page.

If no specific password has been previously defined, use the default password DEFAULT.

4. Select **OK** to turn the access protection on.

You cannot perform the firmware update without entering the password.

To Change the Password. Before the password is changed for the first time, the password is DEFAULT. To change the password, do the following steps:

1. Push the front-panel **Utility** button, and then select Security Menu.
2. Select **Change Password** to display the password input page.
3. Enter your current password.

Use the general purpose knob to select the characters and push the **Enter Character** bezel button after each selection. Then select **OK** to display the New Password input page.

4. Enter a new password.

A password must have at least four characters, and not more than 12 characters. When you enter a new password, the entered characters are displayed on the screen.

5. Select **OK** to activate the new password.

NOTE. To activate or deactivate the access protection, you must enter the password you set. If you forget the password, you must return the instrument to Tektronix to reset the password.

File Operations

This section describes the basic file operations such as browsing files and saving or recalling the instrument setups or waveform data. The instrument setups or the waveform data can be saved in or recalled from files in the internal memory or a USB memory.

Browsing Waveform Files

To browse for a waveform file in the internal memory or in a USB memory, use the **Arb Waveform** Menu. You can select either **Internal** or **USB** as a memory type. Figure E-10 is a screen display example when **USB** is selected.

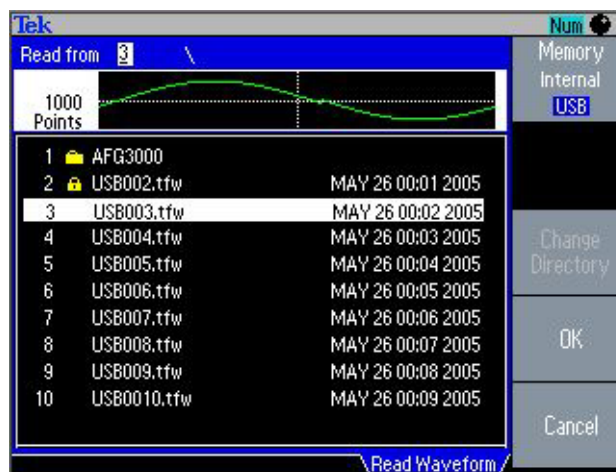

Figure E-10: Browse waveform files (USB memory)

You can select a waveform to be output. The specified waveform is output if the output is enabled.

USB Memory. When you select **USB** from the **Memory** bezel menu, a directory of folder and files on the USB memory are displayed on the screen. You can select a folder or file using the general purpose knob to scroll up and down the rows of the list. The directory of contents are listed in alphabetical order on the screen.

The arbitrary/function generator displays the directory with an index number (the instrument numbers the directory contents from 1 to 500 files). You can also enter an item index number using the numeric keypad to get close to the item you want.

The currently selected item is highlighted. You can open a directory by selecting that row and then pushing the **Change Directory** bezel button. To open a file, select that row and then push **OK**.

Browsing Waveform Files using Edit Menu. You can also browse through waveforms using the **Edit** Menu. Select a file you want to edit and then push the **Read** bezel button. The specified waveform is loaded to the Edit Memory. You can now edit the waveform.

Edit Memory. The currently edited waveform is written to the Edit Memory. Written data in Edit Memory will be lost if the instrument is powered off. To allow this waveform to be used the next time the instrument is turned on, the Edit Memory waveform must be saved into the internal or a USB memory. To save a waveform file to the internal or USB memory, use the **Write to...** submenu.

Saving a Waveform File

Use the **Edit** Menu to save waveform data as a file in the internal memory or a USB memory. To save a waveform data file, do the following:

1. Attach a USB memory to the front-panel USB connector.
2. Push the front-panel **Edit** button to display the Edit menu.
3. Push the **-more-** bezel button to display the second page, and then push the **Write to...** bezel button.
4. Select a memory location:
 - To save a waveform data file to the internal memory, select **Internal**.
 - To save a waveform data file to a USB memory, select **USB**.
5. Use the general purpose knob to scroll a file or directory.
 - Select **Write** to overwrite the existing file.
 - Select **Write As** to display the submenu to enter a file name. (USB only)
6. Select **Make Directory** to create a new directory. (USB only)
7. To lock a file or directory, select a file or directory and then push the **Lock/Unlock** bezel button. Once a file is locked, a lock icon appears next to the file name.

NOTE. When you lock a directory, a lock icon does not appear. Once you lock a directory, you cannot create a new file, new directory, or delete existing files.

To unlock a file or directory, select a locked file or directory and then push the **Lock/Unlock** bezel button. If the lock icon disappears, it indicates that the file is unlocked.

To delete a file or directory, select a file or directory and then push the **Erase** bezel button.

Entering a File Name. When you select **Write As** from the **Write to...** submenu, the character entry box is displayed as shown in Figure E-11.

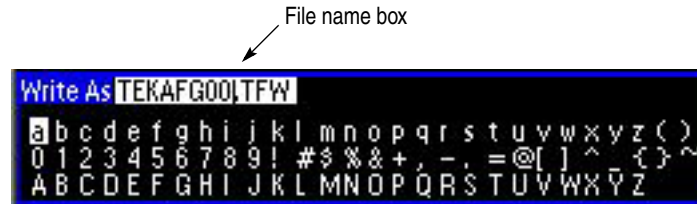

Figure E-11: Write As - Character entry box

English alphabet characters are displayed below the file name box. A selected character is highlighted. You can move the highlighted selection using the general purpose knob. To enter the desired character, push the **Enter Character** bezel button or the front-panel **Enter** button. The selected character is displayed in the file name box.

- To move the cursor in the file name box, use the arrow keys.
- To delete a character in the file name box, push the front-panel **BKSP** key.
- To insert a character in the file name box, move the cursor using the arrow keys, then enter a character.

When the filename is specified, push the **OK** bezel button. To cancel the entry, push the front-panel **Cancel** button.

If you select **Make Directory**, you can create a new directory. The created directory name will be listed. The file listings are in alphabetical order. The specified filename will be highlighted.

NOTE. File names are displayed only in English characters regardless of current instrument language selection. If you use non-English characters to name a file, these characters are replaced by Roman symbols such as #, \$, % on the display screen.

Browsing Instrument Setup Files

To browse instrument setup files in the internal memory or in a USB memory, push the front-panel **Recall** button, and then push the **Memory** bezel button to specify **Internal** or **USB** as a memory type. Figure E-12 is an example of screen when **Internal** is selected.

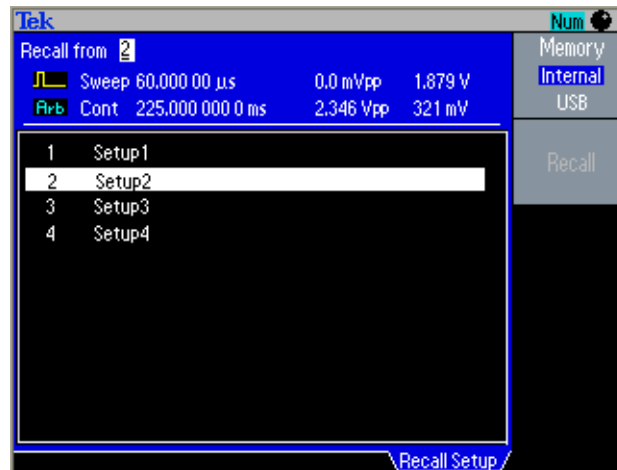

Figure E-12: Recall menu (Internal)

Select a desired setup file, and then push **Recall**. The selected setup file is recalled.

Saving an Instrument Setup File

Use the front-panel **Save** button to save instrument setups in the internal or in a USB memory.

1. Push the front-panel **Save** button to display the Save menu.
2. Select a memory location:
 - To save a setup to the internal memory, select **Internal**.
 - To save a setup to a USB memory, select **USB**.
3. Use the general purpose knob to scroll a file or directory.
 - Select **Save** to overwrite the existing file.
 - Select **Save As** to display the submenu to enter a file name. (USB only)
 - Select **Make Directory** to create a new directory. (USB only)

Entering a File Name. When you select **Save As**, the file name box is displayed as shown in Figure E-13.



Figure E-13: Save As - Character entry box

English alphabet characters are displayed below the file name box. A selected character is highlighted. You can move the highlighted selection using the general purpose knob. To enter the desired character, push the **Enter Character** bezel button or the front-panel **Enter** button. The selected character is displayed in the file name box.

- To move the cursor in the file name box, use the arrow keys.
- To delete a character in the file name box, push the front-panel **BKSP** key.
- To insert a character in the file name box, move the cursor using the arrow keys, then enter a character.

When the filename is specified, push the **OK** bezel button. To cancel the entry, push the front-panel **Cancel** button.

If you select **Make Directory**, you can create a new directory. The created directory name will be listed. The file listings are in alphabetical order. The specified filename will be highlighted.

File Management Conventions

The arbitrary/function generator checks for available space on the USB memory before saving files, and displays a warning message if there is not enough memory for the files you are saving.

The arbitrary/function generator does not have the internal calendar. If you create a file using the file saving menus such as **Save As** or **Write to**, the date and time information is not displayed.

If a file is created by other tools such as ArbExpress software, the date and time information is displayed on the arbitrary/function generator screen.



Index

Index

Symbols

+/- button 1-6

A

ABORt 2-15
Access Protection
 Security menu E-25
Accessories A-1
Action buttons 1-3
Add external signal, Output menu E-12
ADD INPUT connector, rear panel 1-19
Add Noise, Output menu E-12
AFGControl:CSCopy 2-16
Align Phase E-3
Amplitude/High button, shortcut button 1-9
Arb button 1-8
Arb menu E-5
ArbExpress E-14

B

Backup/Restore E-27
Beeper, Utility menu E-24
Bezel buttons 1-13, E-1
Bezel menu 1-11
Bezel menu display area, screen interface 1-13
BKSP button 1-6
Burst Parameter Menu E-11

C

*CAL? 2-16
Calibration E-27
CALibration[:ALL] 2-17
Cancel button 1-6
 To unlock front panel controls 1-10
CH1 Complement, Output menu E-12
CH1/CH2 Output On button 1-7
Change Password
 Security menu E-25
Changing waveform parameters
 Using the bezel menu 1-14
 Using the shortcut buttons 1-17
Channel Copy, Utility menu E-25
Channel Select button 1-7

Chassis ground screw, rear panel 1-20
Cleaning B-1
Click Tone, Utility menu E-24
Clock Ref, Utility menu E-24
*CLS 2-17

Command

 Abbreviating 2-6
 Chaining 2-7
 Message elements 2-2
 Parameter types 2-5
 Query response 2-3
 Special characters 2-6
 Units 2-7
Command entry 2-4
Command errors 3-11
Command groups 2-9
Command syntax 2-1
Connecting to a Ethernet Network E-26
Connecting to a GPIB Network E-26
Contrast, Utility menu E-24
Cursors E-18
Cut, Edit menu E-20

D

Data, Edit menu E-19
DC, More waveform menu E-6
Default button 1-7
 Control settings D-1
Delete a file E-31
Device errors 3-17
Device specific errors 3-15
DIAGnostic[:ALL] 2-18
Diagnostics E-27
DISPlay:CONTRast 2-19
DISPlay:SAVer:IMMediate 2-19
DISPlay:SAVer[:STATe] 2-20
DISPlay[:WINDow]:TEXT:CLEAr 2-21
DISPlay[:WINDow]:TEXT[:DATA] 2-21
Documentation x
Duty/Width button, shortcut button 1-9

E

Edit button 1-6
Edit Memory E-5, E-14, E-31
Edit menu E-14

Enter button 1-6
Erase
 Edit menu E-15
 Save menu E-13
Error/Event Queue 3-10
*ESE 2-22
ESER 3-8
*ESR? 2-23
Event Status Enable Register 3-3, 3-8
Execution errors 3-13
Exponential Decay, More waveform menu E-6
Exponential Rise, More waveform menu E-6
EXT MODULATION CH 1 INPUT connector, rear panel 1-19
EXT MODULATION CH 2 INPUT connector, rear panel 1-19
EXT REF INPUT connector
 Master-slave operation E-26
 Rear panel 1-19
EXT REF OUTPUT connector
 Master-slave operation E-26
 Rear panel 1-19
External Add, Output menu E-12

F

File management conventions E-34
File operations E-30
 To browse instrument setup files E-33
 To browse waveform files E-30
 To enter a file name (Save As) E-34
 To enter a file name (Write As) E-32
Firmware update E-28
 Access protection E-29
Frequency/Period button, shortcut button 1-9
Front panel controls 1-2
Front Panel Overlay, part number A-3
Function buttons 1-8
Fuse adapter A-4

G

Gated burst mode E-11
Gaussian, More waveform menu E-6
GPIB connector, rear panel 1-20

H

Haversine, More waveform menu E-6
HCOPY:SDUMp[:IMMEDIATE] 2-23

Help button 1-6

I

I/O Interface, Utility menu E-23
*IDN? 2-24
Instrument options A-1
Instrument setup file
 Browsing E-33
 Saving E-33
Invert, Output menu E-12
IVI-C driver A-2

L

LabVIEW Plug and Play driver A-2
LAN connector, rear panel 1-20
Language options A-1
Language, Utility menu E-23
Last setup memory 2-25, 2-26, 2-29, 2-37, E-13
Leading/Trailing button, shortcut button 1-9
Level meter 1-11, 1-12
Limit, Output menu E-12
Line, Edit menu E-19
Load Impedance 1-10
 Output menu E-12
Lock a directory E-31
Lock/Unlock
 Edit menu E-15
 Lock or unlock a file E-31
 Save menu E-13
Lorentz, More waveform menu E-6

M

Main display area 1-11, E-23
Manual Trigger button 1-6
MEMory:STATe:DELeTe 2-25
MEMory:STATe:LOCK 2-25
MEMory:STATe:RECall:AUTo 2-26
MEMory:STATe:VALid? 2-24
Menu buttons 1-6
Menu structure E-2
Menu system E-1
Message display area 1-11, 1-12
Messages and codes 3-11
MMEMory:CATalog? 2-27
MMEMory:CDIRectory 2-28
MMEMory:DELeTe 2-28

MMEMory:LOAD:STATe 2-29
 MMEMory:LOAD:TRACe 2-29
 MMEMory:MDIRectory 2-30
 MMEMory:STORE:STATe 2-31
 MMEMory:STORE:TRACe 2-31
 MMEMory:LOCK[:STATe] 2-30
 Modulation Parameter Menu E-7
 More Waveform Menu E-6
 More... button 1-8

N

New, Edit menu E-16
 Noise
 More waveform menu E-6
 Noise Add
 Output menu E-12
 Number of Points, Edit menu E-16
 Numeric input 1-15

O

OCR 3-7
 OENR 3-9
 OEVR 3-7
 Offset/Low button, shortcut button 1-9
 *OPC 2-32
 Operation complete events 3-16
 Operation Condition Register 3-3, 3-7
 Operation Enable Register 3-3, 3-9
 Operation Event Register 3-3, 3-7
 Operations submenu, Edit menu E-17
 *OPT? 2-32
 Option buttons E-1
 Optional accessories A-2
 Options A-1
 Output a user-defined waveform E-5
 Output menu E-12
 How to access E-2
 Output Queue 3-10
 Output status 1-11
 Output status, screen interface 1-11
 OUTPut[1|2]:IMPedance 2-33
 OUTPut[1|2]:POLarity 2-34
 OUTPut[1|2][:STATe] 2-34
 OUTPut:TRIGger:MODE 2-35

P

Password
 How to change E-29
 Paste at Beginning, Edit menu E-21
 Paste at End, Edit menu E-22
 Phase | Delay button, shortcut button 1-9
 Power button 1-3
 Power cord options A-1
 Power On, Utility menu E-13, E-24
 Power-on events 3-15
 Power-on setting E-27
 Programmer Manual, part number A-3
 Programming examples 4-1
 *PSC 2-36
 Pulse button 1-8
 Pulse menu E-4

Q

QCR 3-8
 QENR 3-10
 QEVR 3-8
 Query errors 3-15
 Questionable Condition Register 3-8
 Questionable Enable Register 3-10
 Questionable Event Register 3-8
 Queues 3-10
 Quick Start User Manual, part number A-2

R

Radio button E-1
 Ramp button 1-8
 Ramp menu E-4
 *RCL 2-36
 Read from..., Edit menu E-20
 Rear panel 1-19
 Recall button 1-6
 Recall menu E-13
 Recover Lead Delay, Pulse menu E-4
 Registers 3-4
 Request control events 3-16
 *RST 2-37
 Run Mode buttons 1-7

S

*SAV 2-37

- Save button 1-6
- Save menu E-13
- SBR 3-5
- SCPI
 - Conformance information C-1
 - Standard codes 3-11
- SCPI commands 2-4
 - General rules 2-8
- Screen copy 1-11
- Screen interface 1-11
- Screen Saver, Utility menu E-24
- Screen view formats 1-3
- Secure E-27
 - Utility menu E-24
- Security menu E-29
- Security slot, rear panel 1-20
- Select a channel 1-7
- Service Manual, part number A-3
- Service options A-1
- Service Request Enable Register 3-9
- SESR 3-6
- Setup memory location 0 2-37
- Shortcut buttons 1-9
 - Changing waveform parameters 1-17
- Side-menu buttons 1-13, E-1
- Sin(x)/x, More waveform menu E-6
- Sine button 1-8
- Sine menu E-3
- Soft keys 1-13, E-1
- [SOURce[1|2]]:AM[:DEPTH] 2-38
- [SOURce[1|2]]:AM:INTernal:FREQUency 2-39
- [SOURce[1|2]]:AM:INTernal:FUNCTion 2-40
- [SOURce[1|2]]:AM:INTernal:FUNCTion:EFILe 2-41
- [SOURce[1|2]]:AM:SOURce 2-41
- [SOURce[1|2]]:AM:STATe 2-42
- [SOURce[1|2]]:BURSt:MODE 2-42
- [SOURce[1|2]]:BURSt:NCYCLes 2-43
- [SOURce[1|2]]:BURSt[:STATe] 2-44
- [SOURce[1|2]]:BURSt:TDELay 2-45
- [SOURce[1|2]]:COMBine:FEED 2-46
- [SOURce[1|2]]:FM[:DEViation] 2-47
- [SOURce[1|2]]:FM:INTernal:FREQUency 2-48
- [SOURce[1|2]]:FM:INTernal:FUNCTion 2-49
- [SOURce[1|2]]:FM:INTernal:FUNCTion:EFILe 2-50
- [SOURce[1|2]]:FM:SOURce 2-50
- [SOURce[1|2]]:FM:STATe 2-51
- [SOURce[1|2]]:FREQUency:CENTer 2-52
- [SOURce[1|2]]:FREQUency:CONCurent
 - [:STATe] 2-53
- [SOURce[1|2]]:FREQUency[:CW]:FIXed] 2-54
- [SOURce[1|2]]:FREQUency:MODE 2-55
- [SOURce[1|2]]:FREQUency:SPAN 2-56
- [SOURce[1|2]]:FREQUency:START 2-57
- [SOURce[1|2]]:FREQUency:STOP 2-58
- [SOURce[1|2]]:FSKey[:FREQUency] 2-59
- [SOURce[1|2]]:FSKey:INTernal:RATE 2-59
- [SOURce[1|2]]:FSKey:SOURce 2-60
- [SOURce[1|2]]:FSKey:STATe 2-60
- [SOURce[1|2]]:FUNCTion:EFILe 2-61
- [SOURce[1|2]]:FUNCTion:RAMP:SYMMetry 2-61
- [SOURce[1|2]]:FUNCTion[:SHAPe] 2-62
- [SOURce[1|2]]:PHASe[:ADJust] 2-63
- [SOURce[1|2]]:PHASe:INITiate 2-64
- [SOURce[1|2]]:PM[:DEViation] 2-64
- [SOURce[1|2]]:PM:INTernal:FREQUency 2-65
- [SOURce[1|2]]:PM:INTernal:FUNCTion 2-66
- [SOURce[1|2]]:PM:INTernal:FUNCTion:EFILe 2-67
- [SOURce[1|2]]:PM:SOURce 2-67
- [SOURce[1|2]]:PM:STATe 2-68
- [SOURce[1|2]]:PULSe:DCYCLe 2-70
- [SOURce[1|2]]:PULSe:DELay 2-70
- [SOURce[1|2]]:PULSe:HOLD 2-71
- [SOURce[1|2]]:PULSe:PERiod 2-72
- [SOURce[1|2]]:PULSe:TRANSition[:LEADing] 2-72
- [SOURce[1|2]]:PULSe:TRANSition:TRAILing 2-73
- [SOURce[1|2]]:PULSe:WIDTh 2-74
- [SOURce[1|2]]:PWM[:DEViation]:DCYCLe 2-79
- [SOURce[1|2]]:PWM:INTernal:FREQUency 2-75
- [SOURce[1|2]]:PWM:INTernal:FUNCTion 2-76
- [SOURce[1|2]]:PWM:INTernal:FUNCTion
 - :EFILe 2-77
- [SOURce[1|2]]:PWM:SOURce 2-77
- [SOURce[1|2]]:PWM:STATe 2-78
- [SOURce[1|2]]:SWEep:HTIME 2-80
- [SOURce[1|2]]:SWEep:MODE 2-81
- [SOURce[1|2]]:SWEep:RTIME 2-82
- [SOURce[1|2]]:SWEep:SPACing 2-82
- [SOURce[1|2]]:SWEep:TIME 2-83
- [SOURce[1|2]]:VOLTage:CONCurent[:STATe] 2-84
- [SOURce[1|2]]:VOLTage[:LEVel][:IMMEDIATE][:AM-PLitude] 2-88
- [SOURce[1|2]]:VOLTage[:LEVel][:IMMEDIATE]:HIGH 2-85
- [SOURce[1|2]]:VOLTage[:LEVel][:IMMEDIATE]:LOW 2-86

[SOURce[1|2]]:VOLTage[:LEVel][:IMMEDIATE]:OFF-Set 2-87
[SOURce[1|2]]:VOLTage:LIMit:HIGH 2-89
[SOURce[1|2]]:VOLTage:LIMit:LOW 2-90
[SOURce[1|2]]:VOLTage:UNIT 2-91
SOURce<3|4>:POWer[:LEVel][:IMMEDIATE][:AMPLitude] 2-69
[SOURce]:ROSCillator:SOURce 2-80
Square button 1-8
Square menu E-3
*SRE 2-92
SRER 3-9
Standard accessories A-2
Standard Event Status Register 3-3, 3-6
State buttons 1-7
Status Byte Register 3-5
Status reporting structure 3-1
Status, Utility menu E-24
STATus:OPERation:CONDition? 2-93
STATus:OPERation:ENABLE 2-93
STATus:OPERation[:EVENT]? 2-94
STATus:PRESet 2-94
STATus:QUESTionable:CONDition? 2-95
STATus:QUESTionable:ENABLE 2-95
STATus:QUESTionable[:EVENT]? 2-96
*STB? 2-96
Sweep Parameter Menu E-9
Synchronous operation E-26
System related menu, Utility menu E-24
SYSTem:BEEPPer[:IMMEDIATE] 2-97
SYSTem:BEEPPer:STATe 2-97
SYSTem:ERRor[:NEXT]? 2-98
SYSTem:KCLick[:STATe] 2-98
SYSTem:KLOCK[:STATe] 2-99
SYSTem:PASSword:CDISable 2-99
SYSTem:PASSword[:CENable] 2-100
SYSTem:PASSword[:CENable]:STATe 2-100
SYSTem:PASSword:NEW 2-101
SYSTem:SECurity:IMMEDIATE 2-101
SYSTem:ULANguage 2-102

T

Toggle button selections 1-13
Top Menu button 1-3
 To access the Output menu E-2
TRACe|DATA:CATalog? 2-103
TRACe|DATA:COPI 2-103

TRACe|DATA[:DATA] 2-104
TRACe|DATA[:DATA]:LINE 2-105
TRACe|DATA[:DATA]:VALue 2-106
TRACe|DATA:DEFine 2-107
TRACe|DATA:LOCK[:STATe] 2-108
TRACe|DATA:POINts 2-109
*TRG 2-109
Trigger Input connector 1-10
Trigger Out, Utility menu E-24
Trigger Output connector 1-10
Triggered burst mode E-11
TRIGger[:SEQUence][:IMMEDIATE] 2-111
TRIGger[:SEQUence]:SLOPe 2-110
TRIGger[:SEQUence]:SOURce 2-110
TRIGger[:SEQUence]:TIMer 2-111
Trig'd LED 1-6
*TST? 2-112

U

Unified coarse screw 1-20
Unlock front panel controls 1-10
Upper Menu button 1-3
USB connector
 Front panel 1-10
 Rear panel 1-20
USB memory E-30
 Firmware Update E-28
 Save a screen image 1-11
User request events 3-16
User-defined waveform E-5
Using cursors E-18
Using the menu system E-1
Utility button 1-6
Utility menu E-23

V

View button 1-3
View tab, screen interface 1-11

W

*WAI 2-112
Waveform data file
 Browsing E-30
 Saving E-31
Waveform parameters, how to change 1-14
Write to..., Edit menu E-22

Z

Zoom Fit, Edit menu E-15